

GIORGIO·B@RMAC

CATALOGUE

2024

X5 **ARGO** **LAB** **NEYA** **ONDA**

CATALOGUE 2024

SECTORS

INDEX	pag
Electrochemistry	3
Benchtop Phmeters	4
Portable Phmeters	8
Benchtop Conductivity Meters	14
Portable Conductivity Meters	18
Benchtop Multiparameters	24
Portable Multiparameters	28
Oxymeters	34
Electrodes	37
DHS Laboratory electrodes	39
Laboratory electrodes	40
ORP electrodes	46
Process electrodes	47
Conductivity cells	51
Buffer solutions	53
Calibration solutions	54
Verify solutions	55
Tester	59
Monoparameter	61
Multiparameters	64
Scales	67
Analytical balances	68
Technical balances	70
Industrial balances and moisture analyser	72
Centrifuges	75
Laboratory centrifuges	79
Microcentrifuges	85
Stirrers	87
Heating magnetic stirrers	88
Mechanical stirrers	90
Shaking stirrers	92
Shaking incubators	94
Pipette	96
Ozone generators	96

INDEX	PAG
Thermostatisation	97
Natural oven	100
Forced oven	102
Natural incubators	104
Forced incubators	106
Cooling incubators	108
Climatic chambers	109
Circulating baths	110
Waterbaths	111
Shaking baths	112
Dry baths	113
Ultrasonic baths	115
Argo Freddo	117
Refrigerators	118
Freezer	119
Thermometers	121
PT 100 thermometers	122
Thermistor NTC	124
Thermocouple	125
PT 100 probes	126
Thermocouples probes T/K	127
Datalogger Mini	129
Spectrophotometers	131
Spectrophotometers Onda Touch	132
Accessories and tubes	134
Refractometers	139
Digital refractometers	140
Optical refractometers	142

OUR BRANDS:



ARGO LAB

NEYA
by XS



HOW TO ORDER



Telephone: +39 059 653 274
Monday to Friday from 8.30 to 12.30
and from 14.00 to 18.00.



e.mail: export@giorgiobormac.com

Giorgio Bormac s.r.l.

41012 Carpi MO - Via Della Meccanica, 25
tel. +39 059 653 274 - fax +39 059 653 282
www.giorgiobormac.com

pH METERS



PORTABLE
INSTRUMENTS **5**
WARRANTY
YEARS

BENCHTOP
INSTRUMENTS **3**
WARRANTY
YEARS

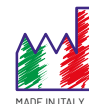

COMPANY WITH
QUALITY MANAGEMENT SYSTEM
UNI EN ISO 9001:2015
CERTIFIED BY CERTIQUALITY



HOW TO CHOOSE

	Violab pH 50	Violab pH 60	pH 8 PRO	pH 80 PRO
Resolution	0,01 pH	0,01 pH	0,001 pH	0,001 pH
Display	coloured LCD	coloured LCD	Coloured graphic	Coloured graphic
GLP calibration	○	●	●	●
Calibration password	○	○	●	●
Calibration points	3	3	5	5
Calibration due alarm	○	●	●	●
Electrode status indication	○	○	●	●
Selective ION	○	○	○	●
Data logger	○	●	●	●
PC / Printer connection	○	●	●	●
Analog view	○	○	●	●
Alarm settings	○	○	●	●
Multilanguage	○	○	●	●
Account manager + audit trail	○	○	○	●
External keyboard	○	○	○	●

pH 80 PRO

- Resolution 0,1 / 0,01 / 0,001 pH
- Advanced user management (4 levels , 15 profiles)
- Data logger, 8000 data memory in GLP
- Analysis Menu for data traceability + Audit trail
- Customisable print templates
- Multiview screen

pH meter, digital benchtop ionmeter for advanced laboratory analyses.

Automatic pH calibration (6 buffer families) or manual, on 5 values.

ISE calibration from 2 to 5 points.

Automatic and manual ORP calibration (1 point).

Calibration due warning and/or measurement block.

Alarm setting and display functions in analogue, 'Hold' and 'Stability' format with titration mode (Tit) and time stability for ISE, self-diagnosis messages.

Advanced user management (Admin, Manager, User,

Guest) with different possibilities of access to instrumental functions.

Different data logger modes (Manual, Automatic, Min/Max, Delta value).

Analysis menu for complete editing of your measurements: you can enter all useful information about the sample and test.

Multiview screen (up to 6 user-selectable parameters can be displayed simultaneously).

Customisable print templates. Multilingual Setup Menu (Ita - Eng - Deu - Fra - Esp - Por).

Free Data-Link+ software available at www.xsinstruments.com for PC data management, including Audit Trail.

2 USB outputs for external keyboard and PC connection. RS232 port for printer connection.

Independently controlled magnetic stirrer (optional).



Measuring range:

pH: -2,000...20,000 (0,001 pH)

mV: -2000...+2000 (0,1 - 1 mV)

ISE: 0,001...19999ppm

ORP: -2000...+2000 mV (0,1 - 1 mV)

Temperature: -30...130,0 °C (0,1 °C)

Equipped with

S7/BNC cable, NT 55 temperature probe, electrode holder stand, coloured buffer solutions, external keyboard, USB cable and multisocket power supply.

Name	Description	P/N
pH 80 PRO STIRRER	Complete with digital electrode XS Standard DHS, magnetic stirrer with adjustable speed	50101392
pH 80 PRO STIRRER	Complete with electrode XS Standard, magnetic stirrer with adjustable speed	50101402
pH 80 PRO STIRRER	Without electrode, with magnetic stirrer with adjustable speed	50101412
pH 80 PRO BASIC	Complete with digital electrode XS Standard DHS, without magnetic stirrer	50101442
pH 80 PRO BASIC	Complete with electrode XS Standard S7, without magnetic stirrer	50101422
pH 80 PRO BASIC	Without electrode and magnetic stirrer	50101432
KEYBOARD	External soft keyboard with USB cable for 80+ Series	50001462
IQ-00 MANUAL 80 SERIES	Printed manual IQ-00 for XS 80 PRO Series	50001472

pH 8 PRO

- Resolution 0,1 / 0,01 / 0,001 pH
- Backlit colour **graphic display**
- Automatic temperature compensation
- Data logger, 1000 data memory in GLP
- Numerical password



Digital benchtop pH meter.

Automatic pH calibration (5 values) on different standard buffer, or custom (2 values).

Automatic and manual 1-point **ORP calibration**.

Recall and printout of calibration data. Graphical display of electrode status.

Calibration due warning and/or measurement block.

Alarm setting and analogic view, "Stop-reading" and 'Stability' with titration mode (Tit), self-diagnosis messages.

Numeric password for protecting saved data and calibration management.

Data logger up to 1000 data in GLP with possibility of sending to printer or PC.

Multilanguage Setup Menu (Ita - Eng - Deu - Fra - Esp - Por).

Free **Data-Link+** software at www.xsinstruments.com for PC data management.

USB output for PC connection and RS232 port for printer connection.

Independently controlled magnetic stirrer (optional).

Measuring range:

pH: -2,000...+16,000 (0,001 pH)

mV: -2000...+2000 (0,1 - 1 mV)

ORP: -2000...+2000 (0,1 - 1 mV)

Temperature: -20...+120,0 °C (0,1 °C)

Equipped with:

S7/BNC cable, NT 55 temperature probe, electrode holder stand, coloured buffer solutions, USB cable and multi-socket power supply.

Name	Description	P/N
pH 8 PRO STIRRER	Complete with digital electrode XS Standard DHS , magnetic stirrer with adjustable speed	50101252
pH 8 PRO STIRRER	Complete with electrode XS Standard , magnetic stirrer with adjustable speed	50101232
pH 8 PRO STIRRER	Without electrode, with magnetic stirrer with adjustable speed	50101242
pH 8 PRO BASIC	Complete with digital electrode XS Standard DHS , without magnetic stirrer	50101192
pH 8 PRO BASIC	Complete with electrode XS Polymer , without magnetic stirrer	50101202
pH 8 PRO BASIC	Without electrode and magnetic stirrer	50101212
IQ-00 MANUAL SERIES 8	Printed manual IQ-00 for XS 8 PRO Series	50001492

ACCESSORIES SERIES 8 / 80

	Description	P/N
MAGNETIC STIRRER	Adjustable speed , with electrode holder and connection cable	50001132
PRINTER RS 232	External printer with normal paper for XS 60 VioLab / 8 / 80 series	50001502
POWER SUPPLY	Power supply 12V/1A for XS 8 PRO and 80 PRO series	50001512

pH 60 *Violab*

- Resolution 0,1 / 0,01 pH
- Automatic and manual **temperature compensation**
- **Data logger** auto and manual , **up to 1000 savings** in GLP
- **Automatic calibration up to 3 points**
- **DHS digital sensors** management



Professional benchtop pH meters with innovative **backlit high definition coloured LCD display**, with possibility of brightness adjustment.
Management of **DHS digital sensors**.

Possibility to select the parameters to show on the display.

The **step by step guide** in setup and calibration allows a simple and immediate use of the device.

Automatic pH calibration with USA and NIST buffers, up to 3 points and 2 points defined by the user.

Automatic ORP calibration on 1 point.

Measurement **stability indication** and possibility to select 3 stability levels.

All operations are constantly monitored and shown to the operator by the **coloured LED** above the display and self-diagnosis messages.

GLP function: Date and time, recall of calibration data and function "Calibration due".

Data logger up to 1000 savings, manual and automatic, PC connection via micro-USB.

Data-Link + software available at www.xsinstruments.com.

RS 232 external **printer connection**



Measuring range:

pH: -2,00...16,00 (0,01 pH)

mV: -1000...+1999 (0,1 - 1 mV)

Temperature: -10...110,0 °C (0,1 °C)



Equipped with:

Electrode holder stand, pH buffer solutions, USB cable, power supply and instructions for use.

Name	Description	P/N
pH 60 VIOLAB DHS ELECTRODE	Complete with digital electrode XS 201 T DHS , with integrated temperature sensor	50101102
pH 60 VIOLAB ANALOG ELECTRODE	Complete with electrode XS 201 T , with integrated temperature sensor	50101092
pH 60 VIOLAB WITHOUT ELECTRODE	With accessories, S7-BNC cable, temperature sensor NT 55, without electrode	50101112
PRINTER RS 232	External printer with normal paper for XS 60 / 8 / 80 series	50001502

pH 50 Violab

- Resolution 0,1 / 0,01 pH
- Automatic and manual **temperature compensation**
- Coloured backlit high definition **LCD display**
- **Automatic calibration up to 3 points**
- **DHS digital sensors** management

Professional benchtop pH meter with innovative **backlit high definition coloured LCD display**, with possibility of brightness adjustment.

Management of **DHS digital sensors**.

Possibility to select the parameters to show on the display.

The **step by step guide** in setup and calibration allows a simple and immediate use of the device.

Automatic pH calibration with USA and NIST buffers, up to 3 points and 2 points defined by the user.

Automatic ORP calibration on 1 point.

Measurement **stability indication** and possibility to select 3 stability levels.

All operations are constantly monitored and shown to the operator by the **coloured LED** above the display and self-diagnosis messages.

Measuring range:

pH: 0,00...14,00 (0,01 pH)

mV: -1000...+1000 (1 mV)

Temperature: 0...100,0 °C (0,1 °C)

Equipped with:

Electrode holder stand, pH buffer solutions, power supply and instructions for use.



Colored LCD display

Name	Description	P/N
pH 50 VIOLAB DHS ELECTRODE	Complete with digital electrode XS 201 T DHS , with integrated temperature sensor	50101032
pH 50 VIOLAB ANALOG ELECTRODE	Complete with electrode XS 201 T , with integrated temperature sensor	50101002
pH 50 VIOLAB WITHOUT ELECTRODE	With accessories, S7-BNC cable, temperature probe NT 55, without electrode	50101012

pH 70 Vio

- Resolution 0,1 / 0,01 pH
- Coloured backlit high definition LCD display
- Automatic and manual **temperature compensation**
- **Data logger** auto and manual , up to 1000 savings in GLP
- GLP functions
- DHS digital sensors management

Professional portable pH meter with **innovative high-resolution colour display**, suitable to work in any conditions, thanks to the automatic and manual brightness adjustment.

Possibility to select the parameters you want to show.

The **step by step guide** in setup and calibration mode allows a simple and intuitive use of the device.

Automatic pH calibration with USA and NIST buffers up to 3 points and 2 points custom defined by the user.

Automatic ORP calibration in 1 point.

Measurement **stability indicator** and possibility of selecting 3 levels of stability.

All operations and errors are constantly monitored and shown to the operator via the **coloured LED** above the display.

GLP function: Date and time, recall of calibration data and function "Calibration due".

Data logger up to 1000 savings, manual and automatic, PC connect via micro-USB.

Data-Link + software available from www.xsinstruments.com.



Measuring range:

pH: -2,00...16,00 (0,01 pH)

mV: -1000...+1999 (0,1 - 1 mV)

Temperature: -10...+110,0 (0,1 °C)

Equipped with:

coloured buffer solutions of pH, USB cable and power supply, instructions for use and plastic carrying case.

Name	Description	P/N
pH 70 VIO DHS ELECTRODE	Complete with digital electrode XS 201 T DHS , with integrated temperature sensor	50110182
pH 70 VIO ANALOG ELECTRODE	Complete with electrode XS 201 T , with t integrated emperature sensor	50110112
pH 70 VIO WITHOUT ELECTRODE	With accessories, S7-BNC cable, temperature probe NT 55, without electrode	50110122
pH 70 VIO FOOD DHS	Complete with penetration digital electrode XS 2 Pore T DHS , for food applications	50110192
pH 70 VIO FOOD	Complete with penetration electrode XS 2 Pore T , for food applications	50110162

pH 7 Vio

- Resolution 0,1 / 0,01 pH
- Coloured backlit high definition LCD display
- Automatic and manual **temperature compensation**
- DHS digital sensors management.

Professional portable pH meter with **innovative high-resolution colour display**, suitable to work in any conditions, thanks also to the possibility to adjust manually contrast and brightness of the display.

Possibility to select the parameters you want to show.

The guide onboard in setup and calibration mode allows a simple and intuitive use of the device.

Automatic pH calibration with USA and NIST buffers up to 3 points and 2 points custom defined by the user.

Automatic ORP calibration in 1 point.

Measurement stability indicator and possibility of selecting 3 levels of stability.

All operations and errors are constantly monitored and shown to the operator via the **coloured LED** above the display.



Measuring range:

pH: 0,00...14,00 (0,01 pH)
 mV: - 1000... + 1000 (1 mV)
 Temperature: 0...+100,0 (0,1 °C)

Equipped with:

coloured buffer solutions of pH, instructions for use and plastic carrying case.

Magnetic support

Name	Description	P/N
pH 7 VIO DHS ELECTRODE	Complete with digital electrode XS 201 T DHS , with integrated temperature sensor	50110072
pH 7 VIO ANALOG ELECTRODE	Complete with electrode XS 201 T , with integrated temperature sensor	50110012
pH 7 VIO WITHOUT ELECTRODE	With accessories, S7-BNC cable, temperature probe NT 55, without electrode	50110022
pH 7 VIO FOOD DHS	Complete with penetration digital electrode XS 2 Pore T DHS , for food applications	50110082
pH 7 VIO FOOD	Complete with penetration electrode XS 2 Pore T , for food applications	50110032

pH

ACCESSORIES pH

pH ELECTRODES

Name	Description	P/N
XS STANDARD T DHS DIGITAL pH ELECTRODE	Digital pH electrode combined with DHS technology. Glass body and cylindrical membrane for general applications. Refillable KCl 3M electrolyte. Excellent chemical resistance and easy to clean. Included with serial number and certificate. Dimensions (LxØ) mm 120x12 - pH 0...14 - Temperature -10...100 °C	32200123
XS STANDARD PH ELECTRODE	pH Electrode combined with S7 head. Glass body, for general use. Refillable KCl 3M Electrolyte. Excellent chemical resistance and easy to clean. With serial number and certificate. Dimensions (LxØ) mm 120x 12 - pH 0...14 - Temperature -10...100 °C.	32200363
XS POLYMER S7	Combined pH Electrode S7 head . Glass Body for general use. Cylindrical membrane. Polymer filling, open pore. For a fast response with high accuracy in samples that might contaminate normal diaphragms. Maintenance-free. Dimensions (LxØ) mm 120x12 - pH 0...14 - Temperature -10...80 °C	32200223
201 T DHS DIGITAL pH ELECTRODE	Digital pH electrode combined with DHS technology. Plastic body for general use. Polymer Filling, ceramic diaphragm. Maintenance-free. Dimensions (LxØ) mm 120x12. pH 0...14 - Temperature 0...60 °C	32200103
201 T PH ELECTRODE	Combined pH electrode with NTC temperature sensor integrated. Plastic body for general applications. Polymer filling with ceramic diaphragm. Maintenance-free. Fixed cable 1 mt., BNC + RCA plug. Dimensions (LxØ) mm 120x12 - pH 0...14 - Temperature 0...60 °C	50002002
201 T / 5 PH ELECTRODE	Combined pH electrode with NTC temperature sensor integrated. Plastic body for general applications. Polymer filling with ceramic diaphragm. Maintenance-free. Fixed cable 5 mt., BNC + RCA plug. Dimensions (LxØ) mm 120x12 - pH 0...14 - Temperature 0...60 °C	50002022
XS 2 PORE T DHS DIGITAL pH ELECTRODE	Digital pH electrode combined with DHS technology. Glass Body. Filled with polymer, maintenance-free. Penetration tip, Ideal for meats and cheese samples. Dimensions (LxØ) mm 35x6 - pH 0...14, Temperature 0...60 °C	32200113
XS 2 PORE T BNC + RCA	Glass Body. Filled with polymer, maintenance-free. With temperature sensor integrated NTC 30 KΩ, Penetration tip. Ideal for meats and cheese samples Fixed cable 1 mt length, pH 0...14, Temperature 0...60 °C	32200323

REDOX ELECTRODES

REDOX ELECTRODE REDOX	Fix cable 1 m , BNC connector, epoxy body. Gel filling, double junction, maintenance-free. Ceramic diaphragm. Range ± 1.000 mV, Temperature 0...60 °C. Dimensions (LxØ) 120 x 12 mm	32105302
REDOX / 5 ELECTRODE REDOX	Fix cable 5 m , BNC connector, epoxy body. Gel filling, double junction, maintenance-free. Ceramic diaphragm. Range ± 1.000 mV, Temperature 0...60 °C. Dimensions (LxØ) 120 x 12 mm	32105102

CONNECTING CABLE

Connecting cable with **S7 head** and BNC plug for XS meters.
Diameter 3 mm, length 1 m.

Name	Description	P/N
BNC	Cable S7-BNC 	33551733

STORAGE SOLUTION

Name	Pack	P/N
Storage solution for electrodes	55 ml	32208043
Storage solution for electrodes	500 ml	32208053

TEMPERATURE PROBES

NT 55 TEMPERATURE SENSOR	Temperature probe NTC 30 K Ω for XS instruments, for liquids and air	50002012
NT 7P TEMPERATURE SENSOR	Temperature probe NTC 30 K Ω , penetration tip , diameter 4 mm, cable fix 1 m	50011122
NT 55 + CABLE KIT	NT 55 temperature probe kit and 1 m S7/BNC cable	50002032

ACCESSORIES

Name	Description	P/N
ECOSTIR MAGNETIC STIRRER	Variable speed magnetic stirrer complete with electrode holder, magnetic stirring rod and main power supply	22001953
ELECTRODE HOLDER MOD: 3900	Flexible electrode holder	50000112
PRINTER	External printer with normal paper for XS 8 / 80 SERIES XS VIOLAB 60 power supply and RS 232 cable	50001502
POWER SUPPLY VIO - PORTABLE	Power supply and cable for XS Vio portable series	50110172
POWER SUPPLY VIOLAB - BENCHTOP	Power supply and cable for XS VioLab benchtop series	50001052

STANDARD BUFFER SOLUTION

With certificate of analysis downloadable from www.xsinstruments.com



○ SACHETS 25 ml

Name	Description	P/N
pH 4.01 (25°C)	Pack of 20 sachets 25 ml, red, with certificate of analysis	51102013
pH 7.00 (25°C)	Pack of 20 sachets 25 ml, green, with certificate of analysis	51102023
pH 10.01 (25°C)	Pack of 20 sachets 25 ml, with certificate of analysis	51102043
SET CAL pH BIS	Pack of 20 sachets 25 ml (10 x pH 4.01 and 10 x pH 7.00)	51102203
SET CAL pH BIS	Pack of 20 sachets 25 ml (7 x pH 4.01, 7 x pH 7.00 and 6 x pH 10.01)	51102213
STORAGE	Pack of 20 sachets 10 ml, pH/ORP Sensor Storage Solution	51102083
H2O	Pack of 20 sachets 25ml, Distilled water for sensor cleaning	51102093

○ BOTTLE 250 ml with integrated calibration compartment

Name	Description	P/N
pH 4,01	±0,01 / 25°C - Red	51100033
pH 7,00	±0,01 / 25°C - Green	51100043
pH 10,01	±0,02 / 25°C - Uncoloured	51100063

○ BOTTLE 500 ml with integrated calibration compartment

Name	Description	P/N
pH 4,01	±0,01 / 25°C - Red	51100133
pH 7,00	±0,01 / 25°C - Green	51100143
pH 10,01	±0,02 / 25°C - Uncoloured	51100163



Brochures **XS Vio** and **XS VioLab** are available on our website www.xsinstruments.com

CONDUCTIVITY METERS



PORTABLE
INSTRUMENTS **5**
WARRANTY
YEARS

BENCHTOP
INSTRUMENTS **3**
WARRANTY
YEARS

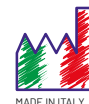

COMPANY WITH
QUALITY MANAGEMENT SYSTEM
UNI EN ISO 9001:2015
CERTIFIED BY CERTIQUALITY



HOW TO CHOOSE

	Violab COND 50	Violab COND 60	COND 8 PRO	COND 80 PRO
COND and TDS	●	●	●	●
Salinity	○	●	●	●
Resistivity	○	○	○	●
Ultra pure water compensation	○	○	○	●
Display	colour backlit LCD	colour backlit LCD	Colour graphic	Colour graphic
GLP Calibration	○	●	●	●
Calibration password	○	○	●	●
Calibration points	4	4	4	4
Calibration due alarm	○	●	●	●
Electrode status indication	○	○	●	●
Data logger	○	●	●	●
PC / printer connection	○	●	●	●
Multilanguage menu	○	○	●	●
Account manager + audit trail	○	○	○	●
External keyboard	○	○	○	●

COND 80 PRO

- Resolution 0,01 μS - 4-rings sensor
- Automatic and manual **temperature compensation**
- **Advanced user management** (4 levels, 15 profiles)
- **Data logger, 8000 data memory in GLP**
- **Menu Analysis for data tracking + Audit Trail**
- **Customisable print templates**
- **Multiview**

Digital benchtop conductivity meter for advanced laboratory analysis. Automatic calibration up to 4 conductivity standards (84, 1413 μS , 12.88 mS, 111.8 mS) from 1 to 4 points with calculation of different cell constants or 1 point of user's choice.

Automatic scale change, automatic and manual temperature compensation (0...100,0 $^{\circ}\text{C}$).

Reference temperature (15...30 $^{\circ}\text{C}$), Linear (0.00...10.00%) and non-linear temperature coefficient for ultrapure water. Compatible with 4-rings and 2-rings cells, with indication of the selected constant.

Calibration due warning and/or measurement lockout.

Alarm setting and analogic view, 'stop-reading', stability indication, self-diagnosis messages.

Advanced user management (Admin, Manager, User, Guest) with different permissions.

Data logger modes: Manual, Automatic, Min/Max, Delta value.

Analysis menu for complete editing of your measurements: you can enter all useful information on the sample and test.

Multiview (up to 6 user-selectable parameters can be displayed simultaneously).

Customisable print templates. Multilingual Setup Menu (Ita - Eng - Deu - Fra - Esp - Por).

Free Data-Link+ software available at www.xsinstruments.com for PC data management, including Audit Trail.

2 USB outputs for external keyboard and PC connection. RS232 for printer connection.

Independently controlled magnetic stirrer (optional).



Measuring range:

Cond: 0,1 μS ...1 S (0,01 μS - automatic)

TDS: 0,1 mg/l...500,0 g/l

Salinity: 0,1 ppm...100,0 ppt

Resistivity: 1,00 Ω ...10,00 M Ω

Temperature: -30... +130,0 (0,1 $^{\circ}\text{C}$)

Equipped with:

Electrode holder stand, conductivity standards, external keyboard, USB cable, multi-socket power supply and user manual.

Name	Description	P/N
COND 80 PRO STIRRER	Complete with conductivity cell EPT 4 with four rings, integrated temperature sensor, and magnetic stirrer with adjustable speed	50103392
COND 80 PRO STIRRER	Complete with EC cell VPT 1 glass/platinum (C=1) with integrated temperature sensor, and magnetic stirrer with adjustable speed	50103402
COND 80 PRO STIRRER	Without EC cell, with magnetic stirrer with adjustable speed	50103412
COND 80 PRO BASIC	Complete with conductivity cell EPT 4 with four rings and integrated temperature sensor, without magnetic stirrer	50103442
COND 80 PRO BASIC	Complete with EC cell VPT 1 glass/platinum (C=1) with integrated temperature sensor, without magnetic stirrer	50103422
COND 80 PRO BASIC	Without EC cell and magnetic stirrer	50103432
KEYBOARD	Soft external keyboard for XS 80 PRO Series	50001462
IQ-00 MANUAL 80 SERIES	Paper manual IQ-00 for XS 80 PRO Series	50001472

COND 8 PRO

- Resolution 0,01 μ S
- Coloured backlit high definition LCD display
- Automatic and manual **temperature compensation**
- **Data logger** auto and manual , up to 1000 savings in GLP

Digital benchtop conductivity meter.
Automatic calibration up to 4 conductivity standards (84, 1413 μ S, 12.88 mS, 111.8 mS) from 1 to 4 points with calculation of different cell constants or 1 point of user's choice.
 Recall and printout of calibration data.
 Automatic scale change, automatic and manual temperature compensation (0...100.0 °C). Reference temperature (15...30 °C).
 Linear temperature coefficient (0.00...10.00%).
 2 rings cell technology with selection and indication of cell constant (0.1 - 1.0 - 10).
Calibration due warning and/or measurement block.
Alarm setting and analogic view, "Stop reading", stability indication, **self-diagnosis messages**.
 Numeric password for protection of saved data and calibration management.
Data logger up to 1000 data in GLP with possibility of printing and data download to PC.
Multilingual Setup Menu (Ita - Eng - Deu - Fra - Esp - Por).
Free Data-Link+ software available at www.xsinstruments.com for PC data management data to PC.
 USB output for PC connection.
 RS232 for printer connection. Independently controlled magnetic stirrer (optional).



Measuring range:
Cond: 0,1 μ S ...500 mS (0,01 μ S - automatic)
TDS: 0,1 mg/l...200,0 g/l
Salinity: 0,1 ppm ...100,0 ppt
Temperature: -20...+120,0 (0,1 °C)

Equipped with:
 Electrode holder stand, conductivity standards, USB cable, multi-socket power supply and user manual.

Name	Description	P/N
COND 8 PRO STIRRER	Complete with epoxy EC cell 2301T (C=1) integrated temperature sensor, and magnetic stirrer with adjustable speed	50103232
COND 8 PRO STIRRER	Without EC cell, with magnetic stirrer with adjustable speed	50103242
COND 8 PRO BASIC	Complete with epoxy EC cell 2301T (C=1) integrated temperature sensor, without magnetic stirrer	50103202
COND 8 PRO BASIC	Without EC cell and magnetic stirrer	50103212
IQ-00 MANUAL SERIES 8	Paper manual IQ-00 for XS 8 PRO Series	50001472

ACCESSORIES 8 / 80 PRO SERIES

Name	Description	P/N
PRINTER	External printer with normal paper for XS VIOLAB 60 - 8 PRO - 80 PRO , power supply and RS232 cable included	50001502
STIRRER	Magnetic stirrer with adjustable speed for XS 8 PRO and 80 PRO series, complete with electrode holder and connecting cable	50001132

COND 60 *Viola*lab

- Resolution 0,01 μ S
- Coloured backlit high definition LCD display
- Automatic and manual temperature compensation
- Data logger auto and manual , up to 1000 savings in GLP
- PC/Printer connection



Professional benchtop conductivity meter with innovative **backlit high definition coloured LCD display**, with possibility of brightness adjustment. Possibility to select the parameters to show on the display.

The **step by step guide** in setup and calibration allows a simple and immediate use of the device.

Automatic conductivity calibration up to 4 points (84; 147; 1413 μ S e 12,88; 111,8 mS) or 1 point custom.

Automatic resolution, reference temperature from 15 to 30 °C, and selectable cell constant (C= 0,1; 1; 10).

Indication of the calibrated points, with icons.

Measurement stability indication.

All operations are constantly monitored and shown to the operator by the **coloured LED** above the display and **self-diagnosis messages**.

GLP function: Date and time, recall of calibration data and function "Calibration due".

Data logger up to 1000 savings, manual and automatic,

PC connection via micro-USB.

Data-Link + software available at www.xsinstruments.com.

RS 232 external printer connection.

Measuring range

Cond: 0,1 μ S ...200 mS (0,01 μ S - automatic)

TDS: 0,1 mg/l...200 g/l

Salinity: 0,1 ppm ... 100 ppt

Temperature: - 10...+ 110,0 (0,1 °C)



Equipped with:

Electrode holder stand, conductivity standards, USB cable, power supply and instructions for use.

Name	Description	P/N
COND 60 VIOLAB WITH EC CELL	Complete with conductivity cell I2301T , integrated temperature sensor, 1 m cable	50103072
COND 60 VIOLAB WITHOUT EC CELL	With accessories, without conductivity cell	50103082

COND 50 *Viola*lab

- Resolution 0,01 μ S
- Coloured backlit high definition LCD display
- Automatic and manual temperature compensation

Professional benchtop conductivity meter with innovative backlit high definition coloured LCD display, with possibility of brightness adjustment. Possibility to select the parameters to show on the display.

The **step by step guide** in setup and calibration allows a simple and immediate use of the device.

Automatic conductivity calibration up to 4 points (84; 147; 1413 μ S e 12,88; 111,8 mS) or 1 point custom.

Automatic resolution, reference temperature from 15 to 30 °C, and selectable cell constant (C= 0,1; 1; 10).

Indication of the calibrated points, with icons.

Measurement **stability indication**.

All operations are constantly monitored and shown to the operator by the **coloured LED** above the display and **self-diagnosis messages**.



Measuring range

Cond 0,1 μ S ...200 mS (0,01 μ S - automatic)

TDS: : 0,1 mg/l...200 g/l

Temperature: 0...+100,0 (0,1 °C)



Equipped with:

Electrode holder stand, conductivity standards and instructions manual.

Name	Description	P/N
COND 50 VIOLAB WITH EC CELL	Complete with conductivity cell 2301T , integrated temperature sensor, 1 m cable	50103002
COND 50 VIOLAB WITHOUT EC CELL	With accessories, without conductivity cell	50103012

Cond 70 \checkmark io

- Resolution 0,01 μ S
- Automatic and manual **temperature compensation**
- **Automatic calibration** on 4 standard points or 1 custom
- **Data logger** auto and manual , **up to 1000 savings in GLP**
- Coloured backlit high definition **LCD display**
- **GLP** functions

Professional conductivity meter with innovative **backlit high definition coloured LCD display**, suitable to work in any conditions, thanks also to the possibility to adjust automatically and manually contrast and brightness of the display.

Possibility to select the parameters you want to show.

The **step by step guide** in setup and calibration mode allows a simple and intuitive use of the device.

Automatic calibration of conductivity up to 4 points or 1 point custom defined by the user.

Adjustable reference temperature and selectable cell constant.

Indication with icons of the calibrated points.

Measurement **stability indicator**.

All operations and errors are constantly monitored and shown to the operator via the **coloured LED** above the display.

GLP function: Date and time, recall of calibration data and function **"Calibration due"**.

Data logger up to 1000 savings, manual and automatic, PC connection via **micro-USB**.

Data-Link + software available at www.xsinstruments.com.

Measuring range:

Cond: 0,1 μ S ... 200,0 mS (0,01 μ S - automatic)

TDS: 0,1 mg/l ... 200,0 g/l

Salinity: 0,1 ppm ... 100 ppt

Temperature: -10...+110,0 (0,1 $^{\circ}$ C)

Equipped with:

Conductivity standards, USB cable, power supply, user manual and carrying case.



Data Link+ Software

Name	Description	P/N
COND 70 VIO WITH CELL	Complete with conductivity cell 2301T with integrated temperature sensor . Cable 1 m	50110512
COND 70 VIO WITHOUT CELL	With accessories, without conductivity cell	50110522

Cond 7 Vio

- Resolution 0,01 μS
- Automatic and manual **temperature compensation**
- Coloured backlit high definition **LCD display**
- **Automatic calibration** on 4 standard points and 1 custom
- 3 selectable **cell constants**

Professional portable conductivity meter with **innovative high resolution color display** for excellent data display in all light conditions, thanks also to the possibility of adjusting display contrast and illumination.

Measurement of **Conductivity, TDS, with Temperature** display.

Online help in setup and calibration allows easy and immediate use of the device.

Automatic conductivity calibration up to 4 points or 1 user-defined point.

Adjustable reference temperatures (15...30 °C) and selectable cell constant (C= 0.1 - 1 - 10).

Indication of calibrated points with icons.

Measurement stability indicator.

All operations are constantly kept under control and signaled to the operator through the colored LED above the display and auto-diagnosis messages.

Measuring range:

Cond: 0,1 μS ... 200,0 mS (0,01 μS - automatic)

TDS: 0,1 mg/l ... 200,0 g/l

Temperature: 0 ... 100,0 (0,1 °C)



Cond



Cond 7 Vio Kit

Equipped with:

Conductivity standards, user manual and carrying case.

Name	Description	P/N
COND 7 VIO WITH CELL	Complete with conductivity cell 2301T with integrated temperature sensor. 1 m cable	50110412
COND 7 VIO WITHOUT CELL	With accessories, without conductivity cell	50110422

ACCESSORIES

CONDUCTIVITY CELLS

Name	Description	P/N
EPT 4 EC CELL	Cell in epoxy body C= 0.55, fixed cable, Multipin connector only for 80 PRO Series. Measuring range : 0.1 μ S...1 S, Temperature 0...+80 °C,	50004062
VP 1 EC CELL	Cell in glass body with platinum plates C=1, fixed cable 1 mt. with BNC plug. Measuring range: 10 μ S...10 mS – Temperature 0...80 °C	50003352
VPT 1 EC CELL	Cell in glass body with platinum plates C=1, with integrated temperature sensor. Fixed cable 1 mt., BNC + RCA Cinch plug. Measuring range: 10 μ S...100 mS – Temperature 0...80 °C	50003382
VPT 01 EC CELL	Steel and PVC cell, C=0,1, with integrated temperature sensor. Fixed cable 1 mt., BNC + RCA plug. Measuring range: 0,1 μ S...1 mS – Temperature 0...60 °C	50004012
VPT 10 EC CELL	Cell in glass body with platinum plates C=10, integrated temperature sensor, fixed cable 1 mt. BNC + RCA Cinch plug. Measuring range: 100 μ S...200 mS..	50004072
VPT 10 H EC CELL	Cell in glass body with platinum plates C=10, integrated temperature sensor, fixed cable 1 mt. BNC + RCA Cinch plug. Measuring range: 100 μ S...500 mS. Only for XS REVIO and COND 80 PRO	50003372
2301 T EC CELL	Cell in epoxy body C=1, with integrated temperature sensor. Fixed cable 1 mt. BNC+RCA cinch plug. Measuring range: 10 μ S...200 mS – Temperature 0...60 °C	50004002
2301 T / 5 EC CELL	Cell in epoxy body C=1, with integrated temperature sensor. Fixed cable 5 mt. BNC+RCA cinch plug. Measuring range: 10 μ S...200 mS – Temperature 0...60 °C	50004022
VPT SOIL EC CELL	Conductivity cell with integrated temperature sensor and penetration tip, C=1, for soil measurement, cable 1,5 m. Measuring range 10 μ S...50 mS	50003362
EPT 1 EC CELL	Cell in epoxy body C=1, with integrated temperature sensor. Fixed cable 1 m, BNC-Cinch. Measuring range 10 μ S...100 mS. For oily or viscous samples.	50004082

TEMPERATURE PROBE

Name	Description	P/N
NT 55 TEMPERATURE SENSOR	Temperature sensor NTC 30K Ω for liquids and air	50002012

BUFFER SOLUTIONS

With **certificate of analysis** downloadable from www.xsinstruments.com

○ SACHETS 25 ml

Name	Description	P/N
EC 1413 μS/cm (25°C)	Pack of 20 sachets, with certificate of analysis	51102053
EC 12880 μS/cm (25°C)	Pack of 20 sachets, with certificate of analysis	51102063
SET CAL COND	Includes 10 x EC 1.413 μ S and 10 x EC 12.880 μ S	51102223
COND REPLACEMENT	Includes 7 x EC 1.413 μ S, EC 12.880 μ S and 6 x deionized H2O	51102253
H2O	Pack of 20 sachets of deionized water	51102093

○ BOTTLE 500 ml , with calibration compartment

Name	Description	P/N
84 μS/cm (25°C)	N.I.S.T. Accuracy \pm 1%	51100613
147 μS/cm (25°C)	N.I.S.T Accuracy \pm 1%	51100623
1413 μS/cm (25°C)	1278 μ S/cm(20°C) - N.I.S.T. Accuracy \pm 1%	51100633
12.880 μS/cm (25°C)	11670 μ S/cm(20°C) - N.I.S.T. Accuracy \pm 1%	51100643

Name	Description	P/N
NEW ECOSTIR STIRRER	Magnetic stirrer, adjustable speed, with magnetic bar and power supply.	22001953
ELECTRODE HOLDER MOD: 3900	Flexible electrode holder	50000112
PRINTER	External printer with normal paper for XS 8 / 80 SERIES XS VIOLAB 60 power supply and RS 232 cable	50001502
CASE IP67	IP 67 waterproof case for Vio portable instruments	50010972
SOFT CASE	Bag with adjustable shoulder strap in eco-sustainable material for Vio portable instruments	50010962
SUPPORT VIO - PORTABLE	Magnetic support for Vio portable instruments	50110252
POWER SUPPLY VIO - PORTABLE	Power supply and cable for XS Revio / 70 Vio	50110172
POWER SUPPLY VIOLAB - BENCHTOP	Power supply and cable for XS VioLab benchtop series	50001052

DATA LINK +

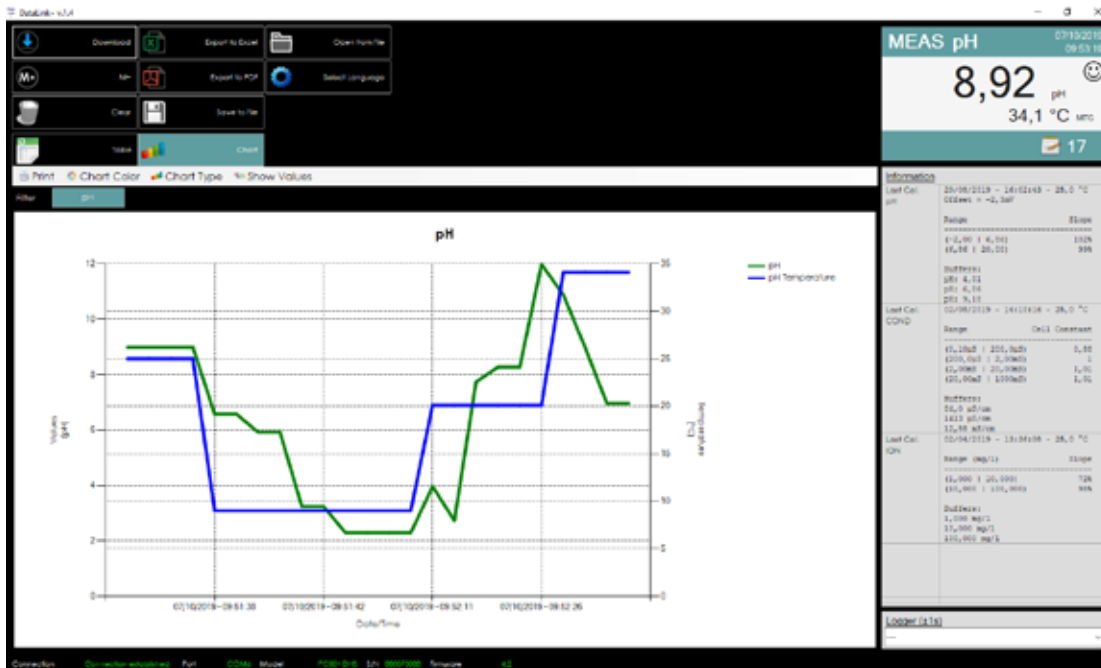

On the software are shown all the information about the instruments and calibrations, like slope and offset.

It is possible to view all saved data in graphic form, to see the trend, or in table form.

It is also possible to export data in Excel and in PDF.

On the top right corner the real time view allows to check measurement directly on the PC.

Multilanguage: English - Italian - French - German - Spanish - Portuguese.

Functions for the remote control of the instruments, like data saving and memory reset.

Software **Data Link +** available for free on our website www.xsinstruments.com.



Brochures **XS Vio** and **XS VioLab** are available on our website www.xsinstruments.com

MULTIPARAMETERS



PORTABLE
INSTRUMENTS **5**
YEARS WARRANTY

BENCHTOP
INSTRUMENTS **3**
YEARS WARRANTY

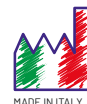

COMPANY WITH
QUALITY MANAGEMENT SYSTEM
UNI EN ISO 9001:2015
CERTIFIED BY CERTIQUALITY



HOW TO CHOOSE

	Violab PC50	Violab PC 60	PC 8 PRO	PC 80 PRO
pH Resolution	0,01 pH	0,01 pH	0,001 pH	0,001 pH
ION	○	○	○	●
COND e TDS	●	●	●	●
Salinity	○	●	●	●
Resistivity	○	○	○	●
Ultra pure water compensation	○	○	○	●
Display	colour backlit LCD	colour backlit LCD	colour graphic	colour graphic
Analogic view	○	○	●	●
GLP Calibration	○	●	●	●
Calibration password	○	○	●	●
Calibrations points	3	3	5	5
Calibration due alarm	○	●	●	●
Electrode status indication	○	○	●	●
Data logger	○	●	●	●
PC / Printer connection	○	●	●	●
Multilanguage	○	○	●	●
Account manager + Audit trail	○	○	○	●
External keyboard	○	○	○	●

PC 80 PRO

- Resolution 0.1 / 0.01 / 0.001 pH - 0.01 μ S
- Automatic and manual **temperature compensation**
- **Advanced user management** (4 levels, 15 profiles)
- **Data logger, 8000 data memory in GLP**
- **Menu Analysis for data tracking + Audit Trail**
- **Customisable print templates**
- **Multiview**



Digital benchtop multiparameter for advanced laboratory analysis.

Multiview display (up to 6 parameters simultaneously).

Automatic or manual 5-points pH calibration with automatic standard recognition.

ISE calibration from 2 to 5 points. Automatic or manual ORP calibration on 1 point.

Automatic EC calibration up to 1 to 4 points with recognition of standards and calculation of different cell constants + 1 manual point.

Automatic scale, automatic and manual temperature compensation (0...100.0 °C).

Reference temperature (15...30 °C), linear (0.00...10.00%) and **non-linear temperature coefficient for ultrapure water**.

Compatible with 4-rings and 2-rings cells, with indication of selected constant.

Calibration due warning and/or measurement block.

Alarm setting and display functions in analogue format, **"Stop-reading", stability indication, self-diagnosis messages**.

Advanced management of Users (Admin, Manager, User, Guest) with different permissions.

Different data logger modes (Manual, Automatic, Min/Max, Delta value).

Analysis menu for complete editing of your measurements: you can enter all useful informations about the sample and test.

Customisable print templates. Multilanguage Setup Menu (Ita - Eng - Deu - Fra - Esp - Por).

Free **Data-Link+** software at www.xsinstruments.com for PC data management, including **Audit Trail**.

2 USB outputs for external keyboard and PC connection. RS232 port for printer connection.

Independently controlled magnetic stirrer (optional).

Measuring range:

pH: -2,000...20,000 (0,001 pH)

mV: -2000...+2000 (0,1 - 1 mV)

ORP: -2000...+2000 (0,1 -1 mV)

ISE: 0.001...19999 ppm

Cond: 0,1 μ S ...1 S (0,01 μ S - automatic)

TDS: 0,1 mg/l...500,0 g/l

Salinity: 0,1 ppm...100,0 ppt

Resistivity: 1,00 Ω ...10,00 M Ω

Temperature: -30...130,0 °C (0,1 °C)

Equipped with:

S7/BNC cable, temperature probe NT 55, electrode holder, buffer solutions, USB cable and power supply.

Name	Description	P/N
PC 80 PRO DHS ELECTRODE + 4 RINGS	Complete with pH XS Standard DHS, EC cell EPT 4 (C=0,55) with integrated temperature sensor, magnetic stirrer with adjustable speed.	50104302
PC 80 PRO DHS ELECTRODE + 2 RINGS	Complete with pH XS Standard DHS, EC cell VPT 1 glass/platinum (C=1) with integrated temperature sensor, magnetic stirrer with adjustable speed.	50104232
PC 80 PRO ELECTRODE + 4 RINGS	Complete with pH XS Standard, EC cell EPT 4 (C=0,55) with integrated temperature sensor, magnetic stirrer with adjustable speed.	50104282
PC 80 PRO ELECTRODE + 2 RINGS	Complete with pH XS Standard, EC cell VPT 1 glass/platinum (C=1) with integrated temperature sensor, magnetic stirrer with adjustable speed.	50104242
PC 80 PRO 4 RINGS CELL	Without pH electrode, EC cell EPT 4 (C=0,55) with integrated temperature sensor, magnetic stirrer with adjustable speed.	50104292
PC 80 PRO 2 RINGS CELL	Without pH electrode, conductivity cell VPT 1 glass/platinum (C=1) with integrated temperature sensor, magnetic stirrer with adjustable speed.	50104252
PC 80+ PRO PH ELECTRODE	With pH electrode XS Standard, without conductivity cell, magnetic stirrer with adjustable speed.	50104262
PC 80 PRO STIRRER	Without pH electrode, without conductivity cell, with magnetic stirrer with adjustable speed.	50104272
KEYBOARD	Soft external keyboard for XS 80 PRO Series	50001462
IQ-00 MANUAL	Paper manual IQ-00 for XS 80 PRO Series	50001472

PC 8 PRO

- Resolution 0,1 / 0,01 / 0,001 pH - 0,01 μ S
- Backlit coloured high-definition **graphic display**.
- **Automatic** and manual **temperature compensation**
- **Data logger** auto and manual, up to **1000 savings in GLP**

Digital benchtop multiparameter.

Automatic pH calibration (5 values) on different standard buffer, or custom (2 values).

Automatic and manual 1-point ORP calibration.

Automatic calibration up to 4 conductivity standards (84, 1413 μ S, 12.88 mS, 111.8 mS) from 1 to 4 points with calculation of different cell constants or 1 point custom. **Recall and printout of calibration data.** Automatic scale, **automatic and manual temperature compensation** (0...100.0 °C).

Reference temperature (15...30 °C). Linear temperature coefficient (0.00...10.00%)

2-rings cell technology with selection and indication of constant (0.1 - 1.0 - 10).

Calibration due warning and/or measurement block.

Alarm setting and analogic view, "Stop-reading", stability indication, self-diagnosis messages

Security password for saved data and calibration management.

Data logger for up to 1000 data points in GLP with possibility of printing and data download to PC.

Multilanguage Setup Menu (Ita - Eng - Deu - Fra - Esp - Por).

Free **Data-Link+** software at www.xsinstruments.com for PC data management.

USB output for PC connection. RS232 port for printer connection.

Independently controlled magnetic stirrer (optional).



PC

Measuring range:

pH: -2,000...16,000 (0,001 pH)

mV: -2000...+2000 (0,1 mV - 1 mV)

ORP: -2000...+2000 (0,1 - 1 mV)

Cond: 0,1 μ S ...500,0 mS (0,01 - automatic)

TDS: 0,1 mg/l...200,0 g/l

Salinity: 0,1 ppm...100,0 ppt

Temperature: -20...120,0 °C (0,1 °C)

Equipped with:

S7/BNC cable, temperature probe NT 55, electrode holder, buffer solutions, USB cable and power supply.

Name	Description	P/N
PC 8 PRO STIRRER	Complete with pH XS Standard DHS, EC cell VPT 1 glass/platinum (C=1) with integrated temperature sensor, magnetic stirrer with adjustable speed.	50104132
PC 8 PRO STIRRER	Complete with pH XS Standard, EC cell VPT 1 glass/platinum (C=1) with integrated temperature sensor, magnetic stirrer with adjustable speed.	50104142
PC 8 PRO STIRRER	Without pH electrode, conductivity cell VPT 1 glass/platinum (C=1) with integrated temperature sensor, magnetic stirrer with adjustable speed.	50104152
IQ-00 MANUAL	Paper manual IQ-00 for XS 8 PRO Series	50001492

ACCESSORIES 8 / 80

Name	Description	P/N
PRINTER	External printer, normal paper with RS 232 cable	50001502
STIRRER	Magnetic stirrer with adjustable speed for 8 and 80 Series, complete with electrode holder and connecting cable	50001132

PC 60 *Viola*lab

- Resolution 0,1 / 0,01 pH - 0,01 μ S
- Automatic and manual **temperature compensation**
- **Data logger** auto and manual , up to 1000 savings in GLP
- PC/Printer connection
- DHS digital sensors management



Professional benchtop multiparameter with innovative **backlit high definition**

coloured LCD display, with possibility of brightness adjustment. Management of DHS digital sensors.

Possibility to select the parameters to show on the display.

The **step by step guide** in setup and calibration allows a simple and immediate use of the device.

Automatic pH calibration with USA and NIST buffers, up to 3 points and 2 points defined by the user.

Automatic ORP calibration on 1 point.

Automatic conductivity calibration up to 4 points (84; 147; 1413 μ S e 12,88; 111,8 mS) or 1 point custom.

Automatic resolution, reference temperature from 15 to 30 °C, and selectable cell constant (C= 0,1; 1; 10).

Indication of the calibrated points, with icons.

Measurement **stability indication** and possibility to select 3 stability levels.

All operations are constantly monitored and shown to the operator by the **coloured LED** above the display and self-diagnosis messages.

GLP function: Date and time, recall of calibration data and function "Calibration due".

Data logger up to 1000 savings, manual and automatic, PC connection via **micro-USB**.

Data-Link + software available at www.xsinstruments.com.

RS 232 external **printer connection**.



Measuring range:

pH: -2,00...16,00 (0,01 pH)

mV: -1000...+1999 mV (0,1 - 1 mV)

Cond: 0,1 μ S ...200,0 mS (0,01 μ S - automatic)

TDS: 0,1 mg/l...200 g/l

Salinity: 0,1 ppm ... 100 ppt

Temperature: -10...110,0 °C (0,1 °C).



Equipped with:

Electrode holder stand, pH and conductivity buffer solutions, USB cable, power supply and user manual.

Name	Description	P/N
PC 60 VIOLAB DHS ELECTRODE	Complete with digital pH electrode XS 201 T DHS and conductivity cell 2301T (C=1), both with integrated temperature sensor	50103942
PC 60 VIOLAB ANALOG ELECTRODE	Complete with pH electrode XS 201 T and conductivity cell 2301T (C=1), both with integrated temperature sensor	50103952
PC 60 VIOLAB WITHOUT ELECTRODE	With conductivity cell 2301T (C=1) with integrated temperature sensor, accessories, cable S7-BNC and temperature sensor NT 55 Without pH electrode	50103972

PC 50 *Violab*

- Resolution 0,1 / 0,01 pH - 0,01 μS
- Automatic and manual **temperature compensation**
- DHS **digital sensors** management

Professional benchtop multiparameter with innovative **backlit high definition coloured LCD display**, with possibility of brightness adjustment.

Possibility to select the parameters to show on the display.

The **step by step guide** in setup and calibration allows a simple and immediate use of the device.

Automatic pH calibration with USA and NIST buffers, up to 3 points and 2 points defined by the user.

Automatic ORP calibration on 1 point.

Automatic conductivity calibration up to 4 points (84; 147; 1413 μS e 12,88; 111,8 mS) or 1 point custom.

Automatic resolution, reference temperature from 15 to 30 °C, and selectable cell constant (C= 0,1; 1; 10).

Indication of the calibrated points, with icons.

Measurement stability indication and possibility to select 3 stability levels.

All operations are constantly monitored and shown to the operator by the **coloured LED** above the display and self-diagnosis messages.



Measuring range:

pH: 0,00...14,00 (0,01 pH)

mV: -1000...+1000 (1 mV)

Cond: 0,1 μS ...200 mS (0,01 μS - automatic)

TDS: 0,1 mg/l...200,0 g/l

Temperature: 0...100,0 °C (0,1 °C).

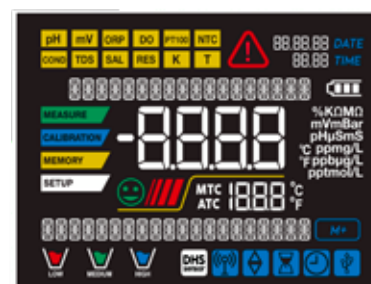

Coloured backlit LCD display

Equipped with:

Electrode holder stand, pH and conductivity buffer solutions, power supply and user manual.

Name	Description	P/N
PC 50 VIOLAB DHS ELECTRODE + CELL	Complete with digital pH electrode XS 201 T DHS and conductivity cell 2301T (C=1), both with integrated temperature sensor	50103892
PC 50 VIOLAB ELECTRODE + CELL	Complete with pH electrode XS 201 T and conductivity cell 2301T (C=1), both with integrated temperature sensor	50103902
PC 50 VIOLAB WITHOUT ELECTRODE	With conductivity cell 2301T (C=1) with integrated temperature sensor, accessories, cable S7-BNC and temperature sensor NT 55 Without pH electrode	50103912

REVIO

WARRANTY
3
YEARS

- 3 Inputs: pH / ORP / ISE - Cond - O₂
- Colour graphic display
- Data logger, manual and automatic, up to 10.000 savings in GLP

Professional portable multiparameter with triple power supply (battery, PC, electric network) with innovative backlit colour display, suitable to work excellently in any conditions, thanks to the automatic and manual adjustment of contrast and brightness.

Possibility to measure pH, mV, ORP, ISE, Conductivity, TDS, Salinity, Resistivity, Dissolved Oxygen and Temperature.

The step by step guide in setup and calibration mode allows a simple and intuitive use of the device.

Simultaneous display of multiple parameters defined by the user.

Automatic pH calibration with USA and NIST buffers up to 5 points and 5 points defined by the user.

Automatic ORP calibration in 1 point.

Automatic calibration of conductivity up to 4 points or 1 point defined by the user.

Adjustable reference temperature and selectable cell constant.

Automatic calibration up to 2 points (0% - 100%).

Indication with icons of the calibrated points.

GLP functions: Date and time, recall of calibration data and setting of calibration deadline.

Manual and automatic data logger with possibility to download data to PC via micro-USB.

Data Link+ software available to download for free at www.xsinstruments.com.

Stability indicator of measurement and possibility to select 3 stability levels. All operations are constantly monitored and reported to the user through the coloured LED above the display and the self-diagnosis messages.



XS Revio connectors

Measuring range

pH: -2,000...20,000 (0,001 pH)

mV: -2000...+2000 (0,1 - 1 mV)

Orp: -2000...+2000 (0,1 - 1 mV)

ISE: 0.001...19999 ppm

Cond: 0,1 μS ...1000 mS (0,1 μS - automatic)

TDS: 0,1 mg/l...500,0 g/l

Salinity: 0,1 ppm ... 100 ppt

Resistivity: 1 Ω ...10 MΩ

DO: 0,0...50 mg/l (0,01 - 0,1 mg/l)

Saturation: 0,0...400 % (0,1 %)

Barometric pressure: 300...1100 mbar (1 mbar)

Temperature: -30...130,0 °C (0,1 °C)

Equipped with:

Field support with 3 holes for electrodes, buffer solutions, USB cable, power supply, instructions for use and carrying case



MODELS

Name	Description	P/N
REVIO DHS KIT	Complete with digital pH electrode 201 T DHS, conductivity cell 2301 T and polarographic sensor , with integrated temperature sensor and fixed cable 3m, in carrying case.	50110952
REVIO KIT IN CARRYING CASE	Complete with pH electrode 201 T, conductivity cell 2301T and polarographic sensor , with integrated temperature sensor and fixed cable 3m, in carrying case.	50110912
REVIO KIT IN SOFT CASE	Complete with pH electrode 201 T, conductivity cell 2301T and polarographic sensor , with integrated temperature sensor and fixed cable 3m, in soft bag.	50110982
REVIO pH ELECTRODE + OXY	Complete with electrode XS 201 T and polarographic sensor , both with integrated temperature sensor and fixed cable 3m, in carrying case.	50110922
REVIO COND + OXY	Complete with conductivity cell 2301T and polarographic sensor , both with integrated temperature sensor and fixed cable 3m, cable S7-BNC and NT55 3m, in carrying case.	50110942
REVIO ONLY INSTRUMENT	Instrument in carrying case with NT55 probe with cable 3m, cable S7-BNC, and accessories	50110932
NEW REVIO ELECTRODE + CELL	Complete with pH electrode 201 T, conductivity cell 2301T , with integrated temperature sensor and fixed cable 3m, in carrying case.	50110992

ACCESSORIES

ELECTRODES AND SPARE PARTS

Name	Description	P/N
201 T - DHS pH ELECTRODE - 3 m	Digital pH electrode combined with DHS technology with integrated temperature sensor. Gel filling with porous diaphragm. Maintenance-free. Fixed cable 3m. pH 0...14, temperature 0...60 °C. Dimensions (L x Ø) mm 120x12	32200153
201 T - ATC pH ELECTRODE - 3 m	Plastic body pH electrode with temperature sensor for general applications. Gel filling with porous separator Maintenance-free. Fixed cable 3 m. pH 0...14, temperature 0...60 °C. Dimensions (L x Ø) mm 120x12	50002072
2301 T EC CELL - 3 m	Conductivity cell C=1 with built-in temperature sensor, epoxy body, cable 3 m. Working range: 10µS...200 mS	50004092
D07 / 3mt OXY SENSOR - 3 m	Polarographic sensor , cable 3 m, 2 replacement membranes, refill solution (30ml)	50010242
REDOX REDOX SENSOR - 3 m	Combined Redox electrode with plastic body for general applications. Fixed cable 3 m with BNC connector. Gel filling with porous separator. Maintenance-free. Working range: ± 1.000 mV, temperature 0...60 °C	51004132
NT 55 T SENSOR - 3 m	Temperature probe NTC 30 KΩ, cable 3 m, for liquids and air	50002082
MEMBRANE	Kit 2 replacement membranes for sensor D07/3MT	50010252
ELECTROLYTE	Refill solution for sensor D07/3MT (30ml)	50010262
0% STANDARD	Zero Oxygen standard - 1 bottle	50010292
0% STANDARD	Zero Oxygen standard - 5 bottles pack	50010272
POWER SUPPLY	Power supply and cable for XS Revio / 70 Vio	50110172
SUPPORT	Magnetic Support for Vio portable instruments	50110252

PC 70 Vio

- Resolution 0,1 / 0,01 pH - 0,01 μ S
- Automatic and manual **temperature compensation**
- **Data logger** auto and manual , **up to 1000 savings in GLP**
- GLP function
- **DHS digital sensors** management.

Professional portable multiparameter with **innovative high-resolution colour display**, suitable to work in any conditions, thanks to the automatic and manual brightness adjustment.

Possibility to select the parameters you want to show.

The **step by step guide** in setup and calibration mode allows a simple and intuitive use of the device.

Automatic pH calibration with USA and NIST buffers up to 3 points and 2 points custom defined by the user.

Automatic ORP calibration in 1 point.

Automatic calibration of conductivity up to 4 points or 1 point custom defined by the user.

Adjustable reference temperature and selectable cell constant.

Indication with icons of the calibrated points.

Measurement **stability indicator** and possibility of selecting 3 levels of stability.

All operations and errors are constantly monitored and shown to the operator via the **coloured LED** above the display.

GLP function: Date and time, recall of calibration data and function "Calibration due".

Data logger up to 1000 savings, manual and automatic, PC connection via micro-USB.

Data-Link + software available at www.xsinstruments.com.

Measuring range:

pH: -2,00...16,00 (0,01 pH)

mV: -1000...+1900 (0,1 mV / 1 mV)

Cond: 0,1 μ S ...200,0 mS (0,01 μ S - automatic)

TDS: 0,1 mg/l ... 200 g/l

Salinity: 0,1 ppm ... 100 ppt

Temperature: -10...110,0 °C (0,1 °C)

Equipped with:

Field support with 3 holes for electrodes, coloured buffer solutions of pH and conductivity, USB cable and power supply, instructions for use and plastic carrying case.



PC 70 Vio kit

Name	Description	P/N
PC 70 VIO DHS ELECTRODE + CELL	With digital pH electrode 201 T DHS and conductivity cell 2301T, both with integrated temperature sensor and cable 1 m	50110872
PC 70 VIO ELECTRODE + EC CELL	With pH electrode 201 T and conductivity cell 2301T, both with integrated temperature sensor and cable 1 m	50110812
PC 70 VIO ONLY EC CELL	Without pH electrode. With conductivity cell 2301 T, temperature probe NT55, S7-BNC cable and accessories	50110822
PC 70 VIO WITHOUT SENSORS	Without ssensors, with temperature probe NT55, S7-BNC cable and accessories	50110842

PC 7 Vio

- Resolution 0,1 / 0,01 pH - 0,01 μ S
- Automatic and manual **temperature compensation**
- DHS digital sensors management.

Professional portable multiparameter with **innovative high-resolution color display**, suitable to work in any conditions, thanks also to the possibility to adjust manually contrast and brightness of the display.

Possibility to select the parameters you want to show.

The **step by step guide** in setup and calibration mode allows a simple and intuitive use of the device.

Automatic pH calibration with USA and NIST buffers up to 3 points and 2 points custom defined by the user.

Automatic ORP calibration in 1 point.

Automatic calibration of conductivity up to 4 points and 1 point custom defined by the user.

Adjustable reference temperature and selectable cell constant.

Indication with icons of the calibrated points.

Measurement **stability indicator** and possibility of selecting 3 levels of stability.

All operations and errors are constantly monitored and shown to the operator via the **coloured LED** above the display.



PC



Protected connectors

Measuring range:

pH: 0,00...14,00 (0,01 pH)

mV: -1000...+1000 (1 mV)

Cond: 0,1 μ S ...200 mS (0,01 μ S - automatic)

TDS: 0,1 mg/l ... 200 g/l

Temperature: 0...100,0 °C (0,1 °C)

Equipped with:

Field support with 3 holes for electrodes, coloured buffer solutions of pH and conductivity, instructions manual and plastic carrying case.

Name	Description	P/N
PC 7 VIO DHS ELECTRODE + CELL	With digital pH electrode 201 T DHS and conductivity cell 2301T, both with integrated temperature sensor and cable 1 m	50110752
PC 7 VIO ELECTRODE + EC CELL	With pH electrode 201 T and conductivity cell 2301T, both with integrated temperature sensor and cable 1 m	50110712
PC 7 VIO ONLY EC CELL	Without pH electrode. With conductivity cell 2301 T, temperature probe NT55, S7-BNC cable and accessories	50110722
PC 7 VIO WITHOUT SENSORS	Without sensors, with temperature probe NT55, S7-BNC cable and accessories	50110742

ACCESSORIES PC

PH ELECTRODE

Name	Description	P/N
XS STANDARD T DHS DIGITAL pH ELECTRODE	Digital pH electrode combined with DHS technology. Glass body and cylindrical membrane for general applications. Refillable KCl 3M electrolyte. Excellent chemical resistance and easy to clean. Included with serial number and certificate. Dimensions (LxØ) mm 120x12 - pH 0...14 - Temperature -10...100 °C	32200123
XS STANDARD PH ELECTRODE	pH Electrode combined with S7 head. Glass body, for general use. Refillable KCl 3M Electrolyte. Excellent chemical resistance and easy to clean. With serial number and certificate. Dimensions (LxØ mm) 120x12 - pH 0...14 - Temperature -10...100 °C.	32200363
XS POLYMER S7	Combined pH Electrode S7 head . Glass Body for general use. Cylindrical membrane. Polymer filling, open pore. For a fast response with high accuracy in samples that might contaminate normal diaphragms. Maintenance-free. Dimensions (LxØ) mm 120x12 - pH 0...14 - Temperature -10...80 °C	32200223
201 T DHS DIGITAL pH ELECTRODE	Digital pH electrode combined with DHS technology. Plastic body for general use. Polymer Filling, ceramic diaphragm. Maintenance-free. Dimensions (LxØ) mm 120x12. pH 0...14 - Temperature 0...60 °C	32200103
201 T PH ELECTRODE	Combined pH electrode with NTC temperature sensor integrated. Plastic body for general applications. Polymer filling with ceramic diaphragm. Maintenance-free. Fixed cable 1 mt., BNC + RCA plug. Dimensions (LxØ) mm 120x12 - pH 0...14 - Temperature 0...60 °C	50002002
201 T / 5 PH ELECTRODE	Combined pH electrode with NTC temperature sensor integrated. Plastic body for general applications. Polymer filling with ceramic diaphragm. Maintenance-free. Fixed cable 5 mt., BNC + RCA plug. Dimensions (LxØ) mm 120x12 - pH 0...14 - Temperature 0...60 °C	50002022

CONNECTION CABLE

Connecting cable with **S7 head** and BNC plug for XS meters.
Diameter 3 mm, lenght 1 m.

Name	Description	P/N
BNC	Cable S7-BNC 	33551733

CONDUCTIVITY CELLS

Name	Description	P/N
VP 1 EC CELL	Cell in glass body with platinum plates C=1, fixed cable 1 mt. with BNC plug. Measuring range: 10µS...10 mS - Temperature 0...80 °C	50004062
VPT 1 EC CELL	Cell in glass body with platinum plates C=1, with integrated temperature sensor. Fixed cable 1 mt., BNC + RCA Cinch plug. Measuring range: 10µS...100 mS - Temperature 0...80 °C	50003352
VPT 01 EC CELL	Steel and PVC cell, C=0,1, with integrated temperature sensor. Fixed cable 1 mt., BNC + RCA plug. Measuring range: 0,1µS...1 mS - Temperature 0...60 °C	50004012
VPT 10 EC CELL	Cell in glass body with platinum plates C=10, integrated temperature sensor, fixed cable 1 mt. BNC + RCA Cinch plug. Measuring range: 100µS...200 mS	50004072
VPT 10 H EC CELL	Cell in glass body with platinum plates C=10, integrated temperature sensor, fixed cable 1 mt. BNC + RCA Cinch plug. Measuring range: 100µS...500 mS. Only for XS REVIO an XS COND 80 PRO	50003372
2301 T EC CELL	Cell in epoxy body C=1, with integrated temperature sensor. Fixed cable 1 mt. BNC+RCA cinch plug. Measuring range: 10µS...200 mS - Temperature 0...60 °C	50004002
2301 T / 5 EC CELL	Cell in epoxy body C=1, with integrated temperature sensor. Fixed cable 5 mt. BNC+RCA cinch plug. Measuring range: 10µS...200 mS - Temperature 0...60 °C	50004022

TEMPERATURE PROBES

Name	Description	P/N
NT 55 TEMPERATURE PROBE	Temperature probe NTC 30 KΩ for liquids and air	50002012
NT 7P TEMPERATURE PROBE	Temperature probe NTC 30 KΩ, penetration tip, diameter 4 mm, fixed cable 1 m	50011122
NT55 + CABLE KIT	Kit Temperature probe NT 55 + cable S7/BNC, 1 m.	50002032

REDOX SENSORS

Name	Description	P/N
REDOX SENSOR	Electrode in epoxy body. Gel filling, double junction, maintenance-free. Ceramic diaphragm. Cable S7-BNC, 1 m. Dimensions (LxØ) mm 120X12 Measuring range: ± 1.000 mV, temperature 0...60 °C	32105302
REDOX / 5 SENSOR	Electrode in epoxy body. Gel filling, double junction, maintenance-free. Ceramic diaphragm. Cable S7-BNC, 5 m. Dimensions (LxØ) mm 120X12 Measuring range: ± 1.000 mV, temperature 0...60 °C	32105102

CALIBRATION KIT - SACHETS BUFFER SOLUTIONS

Name	Description	P/N
SET CAL pH BIS	It contains 10 x pH 4.01 and 10 x pH 7.00, 25 ml	51102203
SET CAL pH TRIS	It contains 7 x pH 4.01, 7 x pH 7.00, 6 x pH 10.01, 25 ml	51102213
SET CAL COND	It contains 10 x EC 1.413 µS and 10 x EC 12.880 µS, 25 ml	51102223
SET CAL PC	It contains 7 x pH 4.01 and 7.00, 6 x EC 1.413 µS, 25 ml	51102233
REPLACEMENT pH	It contains 6 x pH 4.01, pH 7.00, H2O, and 2 x Storage, 25 ml	51102243
REPLACEMENT COND	It contains 7 x EC 1.413 µS, EC 12.880 µS and 6 x deionized H2O, 25 ml	51102253
REPLACEMENT PC	It contains 5 x pH 4.01, pH 7.00 and 1.413 µS, 3 x H2O, 25 ml and 2 x Storage 10 ml	51102263
STORAGE	Storage solution for electrodes 55 ml	32208043
STORAGE	Storage solution for electrodes 500 ml	32208053

ACCESSORIES

Name	Description	P/N
NEW ECOSTIR MAGNETIC STIRRER	Magnetic stirrer, adjustable speed, with magnetic bar and power supply.	22001953
HOLDER MOD: 3900	Flexible electrode holder	50000112
PRINTER	External printer with normal paper for 60 / 8 PRO / 80 PRO Series, power supply and RS 232 cable	50001502
CASE IP67	IP 67 waterproof case for Vio portable instruments	50010972
SOFT CASE	Bag with adjustable shoulder strap in eco-sustainable material for Vio portable instruments	50010962
POWER SUPPLY	Power supply and cable for XS Revio / 70 Vio	50110172
SUPPORT	Magnetic Support for Vio portable instruments	50110252

Oxy 70 Vio

- High accuracy with **low oxygen level**
- High resolution backlit *coloured LCD Display*
- **Automatic compensation** of temperature and pressure
- **Data logger auto and manual, up to 1000 savings** in GLP
- **GLP with date and time of the last calibration.**
- **Auto calibration DO 0%-100%**
- **Optical sensor maintenance free**

Professional **portable oxymeter with innovative backlit high-resolution colour display** for excellent data view in all conditions thanks to the possibility of automatically and manually adjusting the contrast and lighting of the display.

The online guide in setup and calibration mode allows a simple and intuitive use of the device.

Automatic calibration up to two points (0% - 100%).

Automatic compensation of temperature and barometric pressure, manual salinity.

Measurement stability indicator and possibility to select 3 stability levels.

All operations are constantly monitored and reported to the operator via the coloured LED above the display and the self-diagnosis messages.

GLP function: Date and time, recall of calibration data and function "Calibration due".

Data logger up to 1000 savings, manual and automatic, PC connection via micro-USB.

Data-Link + software available at www.xsinstruments.com.

Measuring range:

DO: 0,0...50 mg/l (0,01 - 0,1 mg/l)

Saturation: 0,0...400 % (0,1 - 1 %)

Barometric pressure: 300...1100 mbar (1 mbar)

Temperature: -10...+110,0 °C

Equipped with:

0 Oxygen standard, USB cable and power supply, user manual and plastic carrying case.



Optical sensor

Name	Description	P/N
OXY 70 VIO 2 m	Complete with optical sensor OXY LD070, with integrated temperature sensor. Cable length: 2 m	50110302
OXY 70 VIO 10 m	Complete with optical sensor OXY LD070, with integrated temperature sensor. Cable length: 10 m	50110312
LD070 / 2m SENSOR	Optical sensor for OXY 70 Vio, with integrated temperature sensor. Cable 2 m	50010342
LD070 / 10m SENSOR	Optical sensor for OXY 70 Vio, with integrated temperature sensor. Cable 10 m	50010352
MEMBRANE	Replacement membrane for LD070	50010362
ARMOR STEEL	Steel armor for LD070 / 10 mt	50010372

Oxy 7 Vio

- High resolution backlit *coloured* LCD Display
- Automatic compensation of temperature and pressure
- Auto calibration DO 0%-100%
- Automatic resolution of the measure
- Polarographic sensor
- Polarization timer

Professional portable oxymeter with **innovative backlit high-resolution colour display** for excellent data view in all conditions thanks to the possibility of manually adjusting the contrast and brightness of the display.

The **step by step guide** in setup and calibration mode allows a simple and intuitive use of the device.

Automatic calibration up to two points (0% - 100%).

Automatic compensation of temperature and barometric pressure, manual salinity.

Measurement **stability indicator** and possibility to select 3 stability levels.

All operations are constantly monitored and reported to the operator via the **coloured LED** above the display and the self-diagnosis messages.

Measuring range:

DO: 0,0...50 mg/l (0,01 - 0,1 mg/l)

Saturation: 0,0...400 % (0,1 - 1 %)

Barometric pressure: 300...1100 mbar (1 mbar)

Temperature: 0...+100,0 °C

Equipped with:

0 Oxygen standard, replacement membrane, user manual and plastic carrying case.



Polarographic sensor

Name	Description	P/N
OXY 7 VIO COMPLETE	Complete with polarographic sensor D07/3M with integrated temperature sensor, cable length 3 m, 1 replacement membranes, refill solution (30ml), 0 Oxygen standard, user manual and carrying case	50110202
OXY 7 VIO ECO	Only instrument without oxygen sensor, in Ecopack with user manual.	50110212
D07 / 3m SENSOR	Polarographic sensor, with integrated temperature sensor. Cable 3m, 2 replacements membranes, refill solution (30ml)	50010242
MEMBRANE	Kit 2 replacement membranes for D07/3M	50010252
ELECTROLYTE	Refill solution for D07/3M (30 ml)	50010262
ARMOR PPE	PPE armor for D07/3M	50010282
0% STANDARD	0 Oxygen standard - 1 bottle	50010292
0% STANDARD	0 Oxygen standard - 5 bottles pack	50010272

ACCESSORIES

Name	Description	P/N
IP67 CASE	Waterproof carrying case IP 67 for portable meters Vio	50010972
SOFT CASE	Soft case with adjustable shoulder strap in eco-friendly material for portable meters Vio	50010962
POWER SUPPLY	Power supply and cable for XS REV10 / 70 Vio	50110172
SUPPORT	Magetical support for V10 portable instruments	50110252



ELECTRODES



WARRANTY
6
MONTHS



DHS
Digital High Sensor



QUALITY REPORT

The models XS Standard and XS Flow are supplied with an individual quality report, referring to the electrode serial number on the internal label for proper traceability according to GLP standards of your calibration and pH measurements.

 QUALITY TEST REPORT	
Model	Electrode Type: STANDARD <i>Elektrodentyp / Elettrodo</i>
	Product number: 32200373 <i>Produktnummer / Codice prodotto</i>
	Serial number: 0009 <i>Seriennummer / Numero seriale</i>
Batch	Batch number: 444 <i>Chargennummer / Numero di lotto</i>
Test results	Reading in pH 7 buffer (0 ± 20mV)*: -5 mV <i>Lesen im pH 7 / Lettura in pH 7*</i>
	Reading in pH 4 buffer (174 ± 20mV)*: 169 mV <i>Lesen im pH 4* / Lettura in pH 4*</i>
Technical features	Measuring range: 0...14 pH <i>Messbereich / Range di misura</i>
	Temperature range: -10...80 °C <i>Temperaturbereich / Range di temperatura</i>
	Temperature sensor: <i>Temperatursensor / Sensore di temperatura</i>
	Reference electrolyte: KCl 3M <i>Bezugselektrolyt / Elettrolita di riferimento</i>
<small>* Measurements are performed in Certified Reference Materials. * Die Messungen werden in zertifizierten Referenzmaterialien durchgeführt. * Le misurazioni sono eseguite in materiali di riferimento certificati.</small>	
<small>A change of the measurement values above during storage and use is a normal behavior of the electrochemical sensors. Eine Änderung der Messwerte oberhalb während der Lagerung und der Verwendung ist ein normales Verhalten der elektrochemischen Sensoren. Una variazione dei valori di misura di cui sopra, durante la conservazione e l'uso, è un comportamento normale dei sensori elettrochimici.</small>	
Date	Passed Quality Control 16/02/2023 <i>Bestanden Qualitätskontrolle / Controllo Qualità Effettuato</i>
<small>This document is generated electronically and doesn't require any signature. Dieses Dokument ist elektronisch erzeugt und erfordert keine Unterschrift erforderlich. Questo documento è generato elettronicamente e non richiede alcuna firma.</small>	

HOW TO CHOOSE THE RIGHT ELECTRODE

	GEL	POLYMER	POLYMER TIP	STANDARD	201T / POLYMER PLAST	STANDARD HA	FLAT	STANDARD HF	FOOD	2 PORE SLIM	2 PORE	2 PORE F	FOOD SLIM	SEMIMICRO	MICRO	MICRO P	MICRO SPECIAL	FLOW
Waste water		●	●		●	●												●
Deionized water									●									●
Tap water	●	●	●	●	●				●									●
Food									●	●	●	●	●					
Butter									●	●	●	●	●					
Samples with protein		●	●						●		●		●			●		
Alkali samples						●												
High temperature samples				●		●			●									
Samples in tube for NMR																	●	
Small volume samples							●								●	●	●	
Samples with Hydrofluoric acid								●										
Viscous samples		●	●						●									●
Cosmetics		●	●	●		●			●									●
Cream		●	●						●									●
Detergents	●	●	●	●	●	●			●									●
Aqueous emulsions		●	●	●					●									●
Cheese										●	●	●	●					
Fruit and vegetables										●	●	●	●					
Milk		●	●						●	●	●	●	●					
Mayonnaise									●		●							●
Marmalade		●	●						●		●							●
Bread and pasta			●						●	●	●	●	●					
Leather							●											
Brine	●	●	●	●	●				●									●
Soap		●	●	●					●									●
Samples with low ionic strenght																		●
Aqueous suspensions		●	●	●					●									●
Semi Aqueous suspensions									●									●
Fruit juice		●	●	●					●									●
Surfaces							●											
TRIS swab				●														●
Tip			●							●	●	●	●					●
Titolation				●					●									●
Non Aqueous titolation																		●
Galvanic treatment		●	●			●												●
Water-based paints		●	●	●					●									●
Paints				●					●									●
Wine		●	●	●					●									●
Yogurt		●	●						●	●	●	●	●					●

DHS Electrodes

Digital High Sensor



Intelligent Sensor management

Digital High Sensors are the new pH sensors with internal chip, that store parameters, date of last calibration, model and production batch of the electrode. After connecting the pH DHS sensor to the instrument, with the same technology, all the data stored in the sensor chip are automatically transferred to the instrument and shown on the display.

After a new calibration of the DHS electrode, the data are automatically stored in the electrode chip. If we move this electrode to another DHS-enabled instrument, we can start working immediately and with extreme security as the data from the last calibration will automatically be transferred and used for pH measurements.

Our DHS electrodes have integrated temperature sensor, fixed cable with BNC and RCA connectors and work without an internal battery, this allows to store them as normal pH electrode and can be connected to any instrument with BNC and RCA connection.



Name	Description	P/N
201 T DHS DIGITAL pH ELECTRODE	Digital pH electrode combined with DHS technology. Plastic body for general use. Gel Filling, ceramic diaphragm. Maintenance-free. Dimensions (LxØ) mm 120x12. pH 0...14 - Temperature 0...60 °C	32200103



Name	Description	P/N
STANDARD T DHS DIGITAL pH ELECTRODE	Digital pH electrode combined with DHS technology. Glass body and cylindrical membrane for general applications. Refillable KCl 3M electrolyte. Excellent chemical resistance and easy to clean. Included with serial number and certificate. Dimensions (LxØ) mm 120x12 - pH 0...14 Temperature -10...100 °C	32200123



Name	Description	P/N
FLOW T DHS DIGITAL pH ELECTRODE	Digital pH electrode combined with DHS technology. Glass body. Refillable KCl 3M electrolyte. With Teflon sleeve diaphragm for measurements in suspensions and samples with low conductivity. With serial number and certificate. Dimensions (LxØ) mm 120x12. pH 0...14 Temperature -10...+80 °C	32200133



Name	Description	P/N
2 PORE T DHS DIGITAL pH ELECTRODE	Digital pH electrode combined with DHS technology. Glass Body. Filled with polymer, maintenance-free. Ideal for meats and cheese samples. Dimensions tip (LxØ) mm 35x6 - pH 0...14, Temperature 0...60 °C	32200113







Name	Description	P/N
2 PORE F T DHS DIGITAL pH ELECTRODE	Digital pH electrode combined with DHS technology. Plastic body (PEEK) and glass membrane. Polymer filling, maintenance-free. Ideal for meat and cheese samples. Dimensions tip (LxØ) mm 35x6 - pH 0...14, Temperature 0...60 °C	32200143

Laboratory electrodes

A very famous Swiss manufacturer developed a complete line of laboratory pH, ORP and conductivity electrodes with glass and plastic body. XS Sensors are available with S7 head or fixed cable with BNC or DIN connector plug. For food applications many models are equipped with temperature sensor included for a fast temperature compensation. Some models have internal serial number and quality certificate to work in accordance with GLP rules

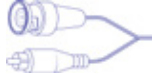

Name	Description		P/N
STANDARD S7	pH Electrode combined with S7 head. Glass body, for general use. Refillable KCl 3M Electrolyte. Excellent chemical resistance and easy to clean. With serial number and certificate. Dimensions (LxØ mm) 120x 12 - pH 0...14 Temperature -10...100 °C.		32200363
STANDARD BNC	With fixed cable 1 mt - BNC connector		32200263
STANDARD DIN	With fixed cable 1 mt - DIN connector		32200273
STANDARD T BNC + RCA	With temperature sensor NTC 30 KΩ, fixed cable BNC+RCA Cinch		32200473
STANDARD T DIN + BANANA	With temperature sensor NTC 30 KΩ, fixed cable DIN+banana 4 mm		32200463
G 214 BNC + BANANA	With temperature probe PT 1000, fixed cable BNC+banana 4 mm Without serial number and certificate.		32200813



Name	Description		P/N
STANDARD HA S7	pH electrode combined for minimal alkali error , S7 head. Glass body and cylindrical membrane. Refillable KCl 3M electrolyte. Excellent chemical resistance and easy to clean. With serial number and certificate. Dimensions (LxØ mm) 120x 12 - pH 0...14 Temperature -10...100 °C.		32200423



Name	Description		P/N
STANDARD HF S7	Combined pH electrode, S7 head. Glass body. With special membrane for measurements in samples containing hydrofluoric acid (0.01 M / 200 mg/l at 20 °C). Refillable KCl 3M electrolyte. Excellent chemical resistance and easy to clean. Dimensions (LxØ mm) 120x 12 - pH 0...14 Temperature -10...100 °C.		32200433



Name	Description	P/N
GEL S7	Combined pH electrode, S7 head. Body in glass for general applications. Cylindrical membrane. Gel filled, maintenance-free. Dimensions (LxØ) mm 120x12 - pH 0...14 Temperature -10...60 °C	32200203



Name	Description	P/N
POLYMER S7	Combined pH Electrode S7 head. Glass Body for general use. Cylindrical membrane. Polymer filled, open pore. For a fast response with high accuracy in samples that might contaminate normal diaphragms. Maintenance-free. Dimensions (LxØ) mm 120x12 - pH 0...14 - Temperature -10...80 °C	32200223



Name	Description	P/N
POLYMER TIP S7	Combined pH electrode with tipped membrane for pH in the soil. S7 head. Glass body. Polymer filled, two open pores. For a fast response with high accuracy in samples may contaminate normal diaphragms. Maintenance-free. Dimensions (LxØ) mm 120x12 - pH 0...14 - Temperature -10...80 °C	32200443



Name	Description	P/N
FLOW S7	Combined pH electrode, S7 screw head. Glass body. Refillable KCl 3M electrolyte. With Teflon sleeve diaphragm for measurements in viscous samples with low conductivity. With serial number and certificate. Dimensions (LxØ) mm 120x12 - pH 0...14 - Temperature -10...80 °C	32200373

FLOW T BNC	With integrated temperature sensor NTC 30 KΩ fixed cable 1 mt lenght BNC+RCA Cinch		32200723
----------------------	--	--	----------

FLOW T DIN	With integrated temperature sensor PT 1000 fixed cable 1 mt lenght DIN+banana 4 mm		32200733
----------------------	--	--	----------

G 221 T BNC + BANANA	With integrated temperature sensor PT 1000 fixed cable 1 mt lenght BNC+banana 4 mm Without serial number and certificate.		32200863
--------------------------------	---	--	----------



Name	Description	P/N
FLAT S7	Combined pH electrode, S7 head. Glass Body. Polymer filled. With flat membrane for surface measurements. Dimensions (LxØ) mm 120x12 - pH 0...14 - Temperature 0...60 °C	32200413



Name	Description	P/N
SEMI MICRO S7	Combined pH electrode, S7 head. Glass body "micro 6". Refillable KCl 3M electrolyte. Suitable for measurements in test tubes. Dimensions tip (LxØ) mm 100 x 6 - pH 0...14 - Temperature 0...100 °C	32200383



Name	Description	P/N
MICRO S7	Combined pH electrode, S7 head. Glass body "micro 3". Refillable KCl 3M electrolyte. For small volume of samples <2 ml. Dimensions tip (LxØ) mm 60 x 3 - pH 0...14 - Temperature 0...100 °C	32200213



Name	Description	P/N
MICRO P S7	Combined pH electrode, S7 head. Glass body "micro 3". Refillable Glycerin KCl electrolyte. Suitable for small volumes in microbiological and biochemical applications. Dimensions tip (LxØ) mm 60 x 3 - pH 0...14 - Temperature 0...100 °C	32200253



Name	Description	P/N
MICRO SPECIAL S7	Combined pH electrode, S7 head, Glass body "micro 3". Refillable KCl 3M electrolyte. For small volume of samples <2 ml. Ideal for NMR tubes. Dimensions tip (LxØ) mm 180x3 - pH 0...14 - Temperature 0...100 °C	32200453

Electrodes for food applications



Name	Description	p/n
FOOD S7	Combined pH electrode with 3 diaphragm, S7 head. Glass body. Refillable Glycerin KCl electrolyte. For dairy and food applications. Dimensions (LxØ) mm 120x12 - pH 0...14 - Temperature -10...100 °C	32200393
FOOD T BNC + RCA	With NTC temperature sensor, 1 m fixed cable ,plug BNC+RCA	32200753



Name	Description	p/n
FOOD SLIM S7	Combined pH electrode, S7 head. Glass body. Refillable Glycerin KCl for sample containing proteins. 6 mm tip for penetration measurements. Dimensions tip (LxØ) mm 25x6 - pH 0...14 - Temperature -10...100 °C	32200243



Name	Description	p/n
ZAVATRODE S7	Combined pH electrode, S7 head. Glass body. Refillable Glycerin KCl for sample containing proteins. 4 mm tip for penetration measurements. Dimensions tip (LxØ) mm 120x4 - pH 0...14 - Temperature 0...60 °C	32200403



Name	Description	p/n
2 PORE S7	Combined pH electrode, S7 head. Glass body. Polymer filling, two open pores, maintenance free. Ideal for meat and cheese applications. Dimensions tip (LxØ) mm 35x6 - pH 0...14 - Temperature 0...60 °C	32200333
2 PORE T BNC + RCA	With integrated temperature sensor NTC 30 KΩ, fixed cable 1 mt length, BNC+RCA Cinch	32200323



Name	Description	p/n
2 PORE SLIM S7	Combined pH electrode, S7 head. Glass body. Polymer filling. Two open pores, maintenance-free. Ideal for meat and cheese applications. Dimensions tip (LxØ) mm 35x4,5 - pH 0...14 - Temperature 0...60 °C	32200283



Name	Description	p/n
2 PORE F S7	Combined pH electrode, S7 head. Plastic body (PEEK) and glass tip. Polymer filling, two open pores, maintenance-free. Ideal for meat and cheese applications. Dimensions tip (LxØ) mm 35x6 - pH 0...14 - Temperature 0...60 °C	32200293
2 PORE F T BNC + RCA	With integrated temperature sensor NTC 30 KΩ fixed cable 1 mt., BNC+RCA.	32200703
2 PORE F T DIN + BANANA	With temperature sensor PT1000, fixed cable 1 mt., plug DIN + banana 4 mm For Knick and WTW instruments.	32200713
G 216 T BNC + BANANA	With temperature sensor PT1000, fixed cable 1 mt., plug BNC + banana 4 mm	32200823





Name	Description	p/n
2 PORE STEEL S7	Combined pH electrode, steel body. Polymer filled, maintenance-free. Ideal for meat and cheese applications or penetration measurements. Dimensions tip (LxØ) mm 50x6 - pH 0...14 - Temperature 0...80 °C	32200653
2 PORE STEEL T BNC + RCA	With integrated temperature sensor NTC 30 KΩ, fixed cable 1 mt., BNC + RCA cinch plug.	32200313
2 PORE STEEL T DIN + BANANA	With temperature sensor NTC 30 KΩ, fixed cable 1 mt., plug DIN + Banana 4mm.	32200643





Name	Description	p/n
2 PORE K S7	Combined pH electrode, S7 head. Steel body with replaceable blade. Polymer filling, two open pores, maintenance-free. Ideal for meat and cheese applications or penetration measurements. Dimensions tip (LxØ) mm 35x6 - pH 0...14 - Temperature 0...60 °C	32200303
2 PORE K WITHOUT BLADE	Only electrode, without knife.	32200343
BLADE	Replaceable knife for 2 Pore K	32200353

Plastic electrodes for general use



Name	Description	p/n
POLYMER PLAST S7	Combined pH electrode, S7 head, with epoxy body. Good chemical resistant. Polymer filling, one open pore and one ceramic diaphragm, for a fast response in samples that contain substances that might contaminate the diaphragm. Maintenance-free. Dimensions (LxØ) mm 120x12 - pH 0...14 - Temperature 0...60 °C	32200493
POLYMER PLAST BNC	With fixed cable 1 mt., BNC plug	 32200503
POLYMER PLAST DIN	With fixed cable 1 mt., DIN plug	 32200513



Name	Description	p/n
201 T BNC	Combined pH electrode with NTC integrated temperature sensor. Epoxy body for general applications. Polymer filling with ceramic diaphragm. Maintenance-free. Fixed cable 1 mt., BNC + RCA plug. Dimensions (LxØ) mm 120x12 - pH 0...14 - Temperature 0...60 °C	 50002002
201 T /3 BNC	201 T with cable 3 mt long	50002072
201 T /5 BNC	201 T with cable 5 mt long	50002022
201 T DIN	With integrated temperature sensor NTC 30 KΩ, fixed cable 1 mt., DIN+ 1 Banana 4mm plug	 50002052
G 210 BNC + BANANA	With integrated temperature sensor PT 1000, fixed cable 1 mt. BNC + 1 Banana 4mm plug	 32200803

Cleaning and maintenance solutions

Name	Volume	p/n
KCL 3M + AgCl Solution	55 ml	32208113
1M LiCl IN ALCOOL ETILICO Solution	100 ml	12005033
3M KCL Solution	55 ml	32208003
3M KCL Solution	500 ml	32208013
GLYCERIN-KCl Solution	55 ml	32208023
KN03 1M FOR ELECTRODE XS STANDARD Ag Solution	55 ml	32208033
ELECTRODES STORAGE Solution	55 ml	32208043
ELECTRODES STORAGE Solution	500 ml	32208053
PROTEIN CLEANING SOLUTION (PEPSIN) FOR FOOD INDUSTRY ELECTRODES	55 ml	32208063
PROTEIN CLEANING SOLUTION (PEPSIN) FOR FOOD INDUSTRY ELECTRODES	250 ml	32208093
DIAPHRAGM CLEANING (THIOUREA) Solution	55 ml	32208073
DIAPHRAGM CLEANING (THIOUREA) Solution	250 ml	32208103
REGENERATION SOLUTION (WITH HF) FOR pH ELECTRODES	55 ml	32208083

ORP Electrodes



Name	Description	P/N
STANDARD ORP S7	Combined pH electrode, S7 head. Glass body. Refillable KCL 3M Electrolyte. Platinum ring for ORP measurements. Dimensions(LxØ)mm 120X12 - Temperature -10...100 °C	32200233



Name	Description	P/N
STANDARD AG S7	Combined electrode, S7 head. Glass body. Refillable KNO3 1M Electrolyte. Silver pin for argentometric titrations. Dimensions(LxØ)mm 120X12- Temperature 0...80 °C	32200483



Name	Description	P/N
FLOW AG S7	Collar diaphragm, S7 head with silver tip for argentometric applications. Dimensions(LxØ)mm 120X12- Temperature 0...80 °C - mV +/- 2000 mV	32200543



Name	Description	P/N
STANDARD KF S7	Glass Body, S7 head. Maintenance-free. Double platinum pins for KF and SO2 titrations Dimensions(LxØ)mm 120X12 - Temperature 0...80 °C	32200523



Name	Description	P/N
PLAST ORP S7	S7 head, epoxy body. Gel filling, double junction, maintenance-free. Ceramic diaphragm. Dimensions(LxØ)mm 120X12 - Temperature 0...60 °C	32200663

PLAST ORP BNC	With fixed cable 1mt., BNC Plug		32200673
-------------------------	---------------------------------	--	----------

Process electrodes



Name	Description	p/n
BASIC PRO S7 - PG 13,5	Combined pH electrode, S7 head. Length 120 mm. Glass body, ceramic diaphragm. Gel filling , maintenance-free. Withstands pressure of 2 bar - pH 0...14 - Temperature 0...60 °C	32201021



Name	Description	p/n
PLASTIC PRO S7 - PG 13,5	Combined pH electrode, S7 head, with epoxy body. Length 120 mm. Good chemical resistant. Polymer filling , open pore. Maintenance-free. Withstands pressure of 6 bar - pH 0...14 - Temperature -10...60 °C	32201101



Name	Description	p/n
POLYMER PRO S7 - PG 13,5	Combined pH electrode, S7 head, glass body. Length 120 mm. Polymer filling with barrier , open pore. Maintenance-free. Withstands pressure of 6 bar - pH 0...14 - Temperature -10...60 °C	32201111



Name	Description	p/n
POLYMER HA PRO S7 - PG 13,5	Combined pH electrode, S7 head, glass body. Length 120 mm. Polymer filling , open pore. Maintenance-free. Sterilizable . Special membrane with low alkaline error and resistant to the metals present in the sample. Withstands pressure of 6 bar - pH 0...14 - Temperature -10...130 °C	32201061



Name	Description	p/n
POLYMER HF PRO S7 - PG 13,5	Combined pH electrode, S7 head, glass body. Length 120 mm. Polymer filling , open pore. Maintenance-free. Special membrane HF resistant (0,01M 200mg at 20°C and 0,05M 1000mg at 50°C). Withstands pressure of 6 bar - pH 0...14 - Temperature 0...100 °C	32201071



Name	Description	p/n
PURE PRO S7 - PG 13,5	Combined pH electrode, S7 head, glass body. Length 120 mm. Refillable KCl 3M electrolyte. Designed for low conductivity samples (<0,2 μS) pH 0...14 - Temperature 0...40 °C	32201081



Name	Description	p/n
PURE PRO GEL S7 - PG 13,5	Combined pH electrode, S7 head, glass body. Length 120 mm. Gel Filling, maintenance-free. Designed for low conductivity samples (<1 μS) Withstands pressure of 6 bar - pH 0...14 - Temperature 0...60 °C	32201171



Name	Description	p/n
GEL HT PRO S7 - PG 13,5	Combined pH electrode, S7 head. Length 120 mm. Glass body with 3 ceramic diaphragms. Gel Filling, maintenance-free. Withstands pressure of 16 bar - pH 0...14 - Temperature 0...130 °C	32201001
GEL HT PRO 225 S7 - PG 13,5	Length 225 mm	32201041



Name	Description	p/n
POLYMER HT PRO S7 - PG 13,5	Combined pH electrode, S7 head, glass body. Length 120 mm. Polymer filling, open pore. Maintenance-free. Withstands pressure of 6 bar - pH 0...14 - Temperature 0...130 °C	32201011
POLYMER HT PRO 225 S7 - PG 13,5	Length 225 mm	32201051



Name	Description	p/n
POLYMER PLUS PRO S7 - PG 13,5	Combined pH electrode, S7 head, glass body. Length 120 mm. Special polymer filling and encapsulated reference system. Maintenance-free. Open pore. Withstands pressure of 6 bar - pH 0...14 - Temperature 0...130 °C	32201121
POLYMER PLUS PRO 225 S7 - PG 13,5	Length 225 mm	32201211



Name	Description	p/n
GEL BIOTECH S7 - PG 13,5	Combined pH electrode, glass body with 1 ceramic diaphragm. Length 120 mm. Maintenance-free, gel filling, pressurized for biotechnology and fermenters, prevents internal pollution by the sample. For SIP and CIP cycles. Withstands pressure of 6 bar - pH 0... 14 - Temperature 0... 130 °C	32201241
GEL BIOTECH 225 S7 - PG 13,5	Length 225 mm	32201251

VP head electrodes



Name	Description	p/n
POLYMER PLUS VP 120 VP HEAD - PT1000	Combined pH electrode, VP Multipin screw head. Glass body. Length 120 mm. Special polymer filling and encapsulated reference system, maintenance-free. Open pore. Complete with PT1000 sensor. Withstands pressure of 6 bar - pH 0... 14 - Temperature 0... 130 °C	32201351
POLYMER PLUS VP 225 VP HEAD - PT1000	Lenght 225mm. With PT1000 sensor.	32201361
POLYMER PLUS VP 120 VP HEAD - PT100	Length 120 mm. With PT100 sensor.	32201401



Name	Description	p/n
POLYMER HT VP 120 VP	Combined pH electrode, VP Multipin screw head. Glass body. Length 120 mm. Polymer filling, maintenance-free. Open pore. Complete with PT1000 sensor. Withstands pressure of 6 bar - pH 0... 14 - Temperature 0... 130 °C	32201301
POLYMER HT VP 225 VP	Lenght 225mm	32201311

Cleaning, maintenance and electrolyte solutions

Name	Volume	p/n
KCL 3M + AgCl Solution	55 ml	32208113
1M LiCl IN ALCOOL ETILICO Solution	100 ml	12005033
3M KCL Solution	55 ml	32208003
3M KCL Solution	500 ml	32208013
GLYCERIN-KCl Solution	55 ml	32208023
KN03 1M FOR ELECTRODE XS STANDARD Ag Solution	55 ml	32208033
ELECTRODES STORAGE Solution	55 ml	32208043
ELECTRODES STORAGE Solution	500 ml	32208053
PROTEIN CLEANING SOLUTION (PEPSIN) FOR FOOD INDUSTRY ELECTRODES	55 ml	32208063
PROTEIN CLEANING SOLUTION (PEPSIN) FOR FOOD INDUSTRY ELECTRODES	250 ml	32208093
DIAPHRAGM CLEANING (THIOUREA) Solution	55 ml	32208073
DIAPHRAGM CLEANING (THIOUREA) Solution	250 ml	32208103
REGENERATION SOLUTION (WITH HF) FOR pH ELECTRODES	55 ml	32208083

Redox process electrodes



Name	Description	p/n
BASIC ORP PLATINUM S7 - PG 13,5	Glass electrode for ORP measurements with gel filling. S7 screw head. Length 120 mm. Withstands pressure of 2 bar - Temperature 0... 60 °C	32201031



Name	Description	p/n
PLASTIC PRO ORP S7 - PG 13,5	Unbreakable epoxy body, S7 screw head. Length 120 mm. Polymer filling, ceramic diaphragm + open pore. Maintenance-free. Withstands pressure of 6 bar - Temperature -10... 60 °C	32201141



Name	Description	p/n
POLYMER ORP S7 - PG 13,5	Glass body. S7 screw head. Length 120 mm. Polymer filling. Open pore. Maintenance-free. Withstands pressure of 6 bar - Temperature -10... 60 °C	32201131



Name	Description	p/n
GEL HT ORP S7 - PG 13,5	S7 screw head. Length 120 mm. Glass body with 3 ceramic diaphragms. Maintenance-free, gel filling. Withstands pressure of 16 bar - Temperature 0... 130 °C	32201091

Process conductivity probe



Name	Description	p/n
SPT1	Conductivity cell in graphite C = 1 with Pt 100 and 8 m cable. Range 0 mS... 10 mS - Temperature 0 ... 60 °C	32390001

Laboratory Conductivity probes



Name	Description		P/N
VP 1	Platinum glass cell C = 1, fixed cable 1 m with BNC. Range 10µS... 100 mS		50004062
VPT 1	Platinum glass cell C = 1, with temperature sensor NTC 30KΩ		50003352
EPT 1	Epoxy body cell C = 1, with temperature sensor NTC 30KΩ		50003382



Name	Description		P/N
VPT 01	Steel/PVC cell C = 0.1, with integrated temperature sensor. Fixed cable 1 m BNC-Cinch. Range 0.1µS... 1 mS		50004012



Name	Description		P/N
VPT 10	Platinum glass cell C = 10, with integrated temperature sensor, fixed cable 1 m BNC-Cinch. Range 100µS... 200 mS		50004072



Name	Description		P/N
VPT 10 H	Platinum glass cell C = 10, with integrated temperature sensor, fixed cable 1 m BNC-Cinch. Range 100µS... 500 mS.		50003372



Name	Description		P/N
2301 T	Epoxy cell C = 1 with integrated temperature sensor, fixed cable 1 m. Working range 10µS... 200 mS		50004002
2301 T / 3	Fixed cable 3 m		50004092
2301 T / 5	Fixed cable 5 m		50004022



Name	Description		P/N
EPT 4 FULL RANGE	PVC-Graphite cell 4 rings C=0,5, 1m cable, integrated temperature sensor. Multipin connector. Measuring range 0,01 µS...1 S. Compatible with PC-Cond 80 Pro		50003362



Name	Description		P/N
VPT SOIL SENSORE	PVC-Graphite cell 4 rings C=0,5, 1m cable, integrated temperature sensor. Multipin connector. Measuring range 0,01 µS...1 S. Compatible with PC-Cond 80 Pro		50004082

Sensors

Cables and accessories

LABORATORY

Cables are provided with S7 head to screw at the electrodes head.
The plug choice is related to the instrument used. Diameter 3 mm, length 1 m.

Name	Description	p/n
BNC	Cable S7-BNC	33551733
DIN	Cable S7-DIN	33551743

PROCESS

Connecting cable for process electrodes. **Diameter 5 mm.**
Plug and length of the cable must be chosen based on the application.

Name	Description	p/n
CABLE 5 MM	Coaxial cable with antistatic sheath for electrodes, diameter 5mm	33550533
S7 HEAD	Only S7 head for 5mm cable	33412913
BNC	Only BNC plug for 5 mm cable	33412923
DIN	Only DIN plug for 5 mm cable	33550903

	Length	p/n
PRE - ASSEMBLED CABLE WITH S7 HEAD - OPEN WIRES	3 m	33550733
	5 m	33550663
	10 m	33550803
	20m	33550763
PRE- ASSEMBLED CABLE WITH S7 HEAD - BNC PLUG	1 m	33550673
	3 m	33550743
	5 m	33550563
	10 m	33550753
	20 m	33550773
PRE- ASSEMBLED CABLE WITH VP 6 FOR ELECTRODE WITH PT100 - PT1000	3 m	33551091
	5 m	33551101
	10 m	33551111

BUFFER SOLUTIONS



XS GREEN LINE SOLUTIONS CALIBRATION AND QUALITY

pH and conductivity measurements and redox potential are routine operations in most laboratories and processes. Reliability and accuracy of measurements are essential for the quality control. The XS Green Line Solutions range suits your needs and guarantees an impeccable calibration.



PROFESSIONAL

XS PROFESSIONAL **ASSURANCE AND ACCREDITATION**

The more accurate the pH and conductivity measurements are, the more reliable the calibration solutions are. XS Professional solutions are a guarantee of metrological traceability of your measurement chain and are ideal for regulated areas. Traceability is ensured by the certifications of accredited external calibration laboratories UNI CEI EN ISO/IEC 17025. pH buffer solutions are DKD-DAkkS certified by calibration at the ZMK Zentrum für Messen und Kalibrieren. Conductivity standards are DANAK certified by calibration at the DFM Danish Institute of Fundamental Metrology. Upon request, it is available the Certification Report in accordance to ISO 17034.



BASIC

XS BASIC **TRACEABILITY AND RELIABILITY**

XS standard solutions are traceable to the IUPAC pH scale, using an unbroken chain of comparisons directly to NIST Standard Reference materials.

Each solution is provided with the Certificate of Analysis of the GIORGIO BORMAC internal Laboratory, which guarantees quality, traceability and accuracy. XS Basic solutions are your perfect partner to verify your sensors and measurement systems every day.

XS PROFESSIONAL pH

All solutions are ISO 9001 - DAkkS/DKD certified.
The Certificate is available on our website: www.xsinstruments.com

○ BOTTLE 250 ml

Name	Description	p/n
pH 4.01	±0,02 / 25°C - Red	51300003
pH 7.00	±0,02 / 25°C - Green	51300013
pH 9.21	±0,02 / 25°C - Blue	51300023
pH 10.01	±0,02 / 25°C - Yellow	51300033

○ BOTTLE 500 ml

Name	Description	p/n
pH 4.01	±0,02 / 25°C - Red	51300103
pH 7.00	±0,02 / 25°C - Green	51300113
pH 9.21	±0,02 / 25°C - Blue	51300123
pH 10.01	±0,02 / 25°C - Yellow	51300133

XS PROFESSIONAL COND

With DFM and N.I.S.T traceability,
The Certificate is available on our website: www.xsinstruments.com



○ BOTTLE 280 ml Glass

Name	Description	p/n
1,3 µS/cm (25°C)	DFM. Accuracy ±0,1µS	51300303
5,0 µS/cm (25°C)	DFM. Accuracy ±0,1µS	51300313

○ BOTTLE 500 ml with built-in calibration compartment

Name	Description	p/n
84 µS/cm (25°C)	DFM. Accuracy ±1%	51300323
147 µS/cm (25°C)	DFM. Accuracy ±1%	51300333
1413 µS/cm (25°C)	1278 µS/cm (20°C) - DFM. Accuracy ±1%	51300343
12.880 µS/cm (25°C)	11670 µS/cm (20°C) - DFM. Accuracy ±1%	51300353

XS BASIC

BUFFER SOLUTIONS IN SACHETS

WITH N.I.S.T. TRACEABILITY.



○ SINGLE BUFFER

Name	Description	p/n
pH 4.01 (25°C)	Pack of 20 sachets 25 ml, red, with certificate of analysis	51102013
pH 7.00 (25°C)	Pack of 20 sachets 25 ml, green, with certificate of analysis	51102023
pH 10.01 (25°C)	Pack of 20 sachets 25 ml, with certificate of analysis	51102043
EC 1413 μS/cm (25°C)	Pack of 20 sachets 25 ml, with certificate of analysis	51102053
EC 12880 μS/cm (25°C)	Pack of 20 sachets 25 ml, with certificate of analysis	51102063
STORAGE	Pack of 20 sachets 10 ml, pH/ORP Sensor Storage Solution	51102083
H2O	Pack of 20 sachets 25ml, Distilled water for sensor cleaning	51102093

○ CALIBRATION SET

Name	Description	p/n
SET CAL pH BIS	Pack of 20 sachets 25ml (10 x pH 4.01 and 10 x pH 7.00)	51102203
SET CAL pH BIS	Pack of 20 sachets 25ml (7 x pH 4.01, 7 x pH 7.00 and 6 x pH 10.01)	51102213
SET CAL COND	Pack of 20 sachets 25ml (10 x EC 1.413 μS and 10 x EC 12.880 μS)	51102223
SET CAL PC	Pack of 20 sachets 25ml (7 x pH 4.01, 7 x pH 7.00 and 6 x EC 1.413 μS)	51102233
REPLACEMENT pH	Pack of 20 sachets 25ml (6 x pH 4.01, 6 x pH 7.00, 6 x H2O distilled water and 2x Storage 10 ml)	51102243
REPLACEMENT COND	Pack of 20 sachets 25ml (7 x EC 1.413 μS, 7 x EC 12.880 and 6 x H2O distilled water)	51102253
REPLACEMENT PC	Pack of 20 sachets 25ml (5 x pH 4.01, 5 x pH 7.00, 5 x 1.413 μS, 3 x H2O distilled water and 2 x Storage 10 ml)	51102263

DISPOSABLE BOTTLE 55 ml



Name	Description	p/n
pH 4,01	±0,02 / 25°C - Red	32383123
pH 7,00	±0,02 / 25°C- Green	32383133
pH 9,00	±0,02 / 25°C- Blue	32383143
pH 10,01	±0,02 / 25°C- Uncoloured	32382903
465 mV	± 5mV / 25°C- Yellow	32383163
475 mV	± 5mV / 25°C- Yellow	32383153
EC 84 μS/cm	± 1% / 25°C - Uncoloured	60000613
EC 1413 μS/cm	± 1% / 25°C - Uncoloured	60000423
EC 12880 μS/cm	± 1% / 25°C - Uncoloured	60000433

pH BUFFERS

With N.I.S.T traceability.

The Certificate is available on our website: www.xsinstruments.com



○ BOTTLE 250 ml with built-in calibration compartment

Name	Description	p/n
pH 4,01	±0,02 / 25°C - Red	51100033
pH 7,00	±0,02 / 25°C - Green	51100043
pH 9,00	±0,02 / 25°C - Blue	51100053
pH 9,21	±0,02 / 25°C - Blue	51100073
pH 10,01	±0,02 / 25°C - Uncoloured	51100063

○ BOTTLE 500 ml with built-in calibration compartment

Name	Description	p/n
pH 4,01	±0,02 / 25°C - Red	51100133
pH 7,00	±0,02 / 25°C - Green	51100143
pH 9,00	±0,02 / 25°C - Blue	51100153
pH 9,21	±0,02 / 25°C - Blue	51100173
pH 10,01	±0,02 / 25°C - Uncoloured	51100163



○ POLITAINER 5000 ml (5 L)

Name	Description	p/n
pH 4,01	±0,02 / 25°C - Red	51100233
pH 7,00	±0,02 / 25°C - Green	51100243
pH 9,00	±0,02 / 25°C - Blue	51100253
pH 9,21	±0,02 / 25°C - Blue	51100273
pH 10,01	±0,02 / 25°C - Uncoloured	51100263

CONDUCTIVITY STANDARD

With N.I.S.T traceability and certificate downloadable from our website: www.xsinstruments.com

○ BOTTLE 280 ml glass

Name	Description	p/n
1,3 µS/cm (25°C)	N.I.S.T. Accuracy ±0,1µS	51100503
5,0 µS/cm (25°C)	N.I.S.T. Accuracy ±0,1µS	51100513



○ BOTTLE 500 ml with built-in calibration compartment

Name	Description	p/n
84 µS/cm (25°C)	N.I.S.T. Accuracy ±1%	51100613
147 µS/cm (25°C)	N.I.S.T Accuracy ±1%	51100623
1413 µS/cm (25°C)	1278 µS/cm (20°C) - N.I.S.T. Accuracy ±1%	51100633
12.880 µS/cm (25°C)	11670 µS/cm (20°C) - N.I.S.T. Accuracy ±1%	51100643



REDOX / ORP STANDARD

Name	Description	p/n
200 mV (25°C)	± 5mV Bottle 250 ml	51100303
465 mV (25°C)	± 5mV Bottle 55 ml	32383163
475 mV (25°C)	± 5mV Bottle 250 ml	51100313
475 mV (25°C)	± 5mV Bottle 500 ml	51100323
650 mV (25°C)	± 5mV Politainer 5 l	51100333

CLEANING AND MAINTENANCE SOLUTIONS

Name	Pack	p/n
Solution 3M KCL	55 ml	32208003
Solution 3M KCL	500 ml	32208013
Solution GLYCERIN-KCl	55 ml	32208023
Solution KNO ₃ 1M for Electrode STANDARD Ag	55 ml	32208033
Solution STORAGE for Electrodes	55 ml	32208043
Solution STORAGE for Electrodes	500 ml	32208053
Solution PROTEINS CLEANING (PEPSIN) for FOOD application Electrodes	55 ml	32208063
Solution PROTEINS CLEANING (PEPSIN) for FOOD application Electrodes	250 ml	32208093
Solution DIAPHRAGM CLEANING (THIOUREA)	55 ml	32208073
Solution DIAPHRAGM CLEANING (THIOUREA)	250 ml	32208103
Solution REGENERATION (with HF) for pH Electrodes	55 ml	32208083



Brochures **XS Buffer solutions** is available on our website
www.xsinstruments.com

TESTER



SENSOR
WARRANTY
6
MONTHS

ELECTRONIC
PART
WARRANTY
1
YEAR



IP67
WATERPROOF



APPLICATIONS:

- FARMING
- WATER AND WASTEWATER TREATMENT
- HYDROPONIC CROPS AND AQUARIUMS
 - ENVIRONMENTAL MONITORING
- POOLS AND THERMAL CENTERS
- FOOD AND BEVERAGE
 - COOLING TOWER
 - GALVANIC
- GRAPHIC INDUSTRY
- SCHOOLS

SELECTION GUIDE

	PX4	pH5	pH5FOOD	COND 5	ORP 5	PC 5	PC 6
pH	●	●	●	○	○	●	●
Redox	●	○	○	○	●	○	●
Conductivity	○	○	○	●	○	●	●
TDS	○	○	○	●	○	●	●
Salinity	○	○	○	●	○	●	●
Temperature	●	●	●	●	●	●	●
pH measuring range	-2 ... 16	-2 ... 16	-2 ... 16	-	-	-2...16	-2...16
Resolution	0.01	0.01	0.01	-	-	0.01	0.01
Calibration points	1...3	1...3	1...3	-	-	1...3	1...3
Stability indications	Yes	Yes	Yes	Yes	Yes	Yes	Yes
mV (pH) measuring range	-1000...+1000 mv	-1000...+1000 mv	-1000...+1000 mv	-	-	-1000 ...+1000mv	-1000...+1000 mv
Resolution	0,1/ 1 mv	0,1/ 1 mv	0,1/ 1 mv	-	-	0,1/ 1 mv	0,1/ 1 mv
mV (ORP) measuring range	-1000...+1000 mv	-	-	-	-1000...+1000 mv	-	-1000...+1000 mv
Resolution	0,1/ 1 mv	-	-	-	0,1/ 1 mv	-	0,1/ 1 mv
Calibration	1 point	-	-	-	1 point	-	1 point
COND measuring range	-	-	-	0,01uS...199,99 mS	-	0,01uS...199,99mS	0,01uS...199,99mS
Resolution	-	-	-	Auto	-	Auto	Auto
Calibratin point	-	-	-	1...3	-	1...3	1...3
Reference T	-	-	-	20 / 25 °C	-	20 / 25 °C	20 / 25 °C
TDS measuring range	-	-	-	0,01ppm...199,9ppt	-	0,01ppm...199,9ppt	0,01ppm...199,9 ppt
TDS factor	-	-	-	0.40 ... 1.00	-	0.40 ... 1.00	0.40 ... 1.00
Salinity measuring range	-	-	-	0,1 mg/l ... 100,0 g/l	-	0,1 mg/l...100,0 g/l	0,1 mg/l...100,0 g/l
Temperature range	0 ... 60 °C	0 ... 60 °C	0 ... 60 °C	0 ... 60 °C	0 ... 60 °C	0 ... 60 °C	0 ... 60 °C
Display	3 colour	3 colour	3 colour	3 colour LCD	3 colour LCD	3 colour	3 colour
IP protection	IP 67	IP 67	IP 67	IP 67	IP 67	IP 67	IP 67
Sensor	Replaceable	Replaceable	Replaceable	Replaceable	Replaceable	Replaceable	Replaceable
Code	50014143	50014063	50014113	50014213	50014313	50014263	50014293



The KIT includes: sachets of buffer solutions 25 ml, calibration cap, lanyard, tissues, quick manual and cardboard case.

pH 1

○ pH

IP67 watertight portable pH meter. Resolution 0.1 pH with microprocessor and fixed sensor. Push-button calibration on 1 or 2 points (choosing between pH 4, 7, 10). Wide LCD display with indication of the buffers used for calibration and measurement stability. **Automatic temperature compensation.** Auto power off function. **Self-diagnosis messages: low batteries, calibration errors.** Power supply with 2 x 1.5V AAA batteries included, compatible with rechargeable batteries too. 6-month warranty on electronic parts.

Measuring range: pH 0,0...14,0 (0,1 pH). Working temperature: 0..50°C

The KIT includes: 1 sachet x 25 ml pH 7 and pH 4 buffer solution , 1 sachet of storage solution, calibration cap, lanyard, tissues, quick manual and cardboard case.



Tester

Name	Description	p/n
pH 1 KIT	pH 1 Kit complete	50014013
pH 1 ECOPACK	pH 1, batteries 1,5 V AAA, lanyard, tissues, storage	50014003

COND 1

○ Conductivity - TDS

IP67 watertight portable conductivity meter for Conductivity and TDS measurement. Indication of the buffers used for calibration and measurement stability. Auto power off function. Self-diagnosis messages. Power supply with 2 x 1.5V AAA batteries included, compatible with rechargeable batteries too. 6-month warranty on electronic parts.

Measuring range: COND 0,01 µS...200 mS; TDS 0,01 ppm...199,9 ppt. Working temperature: 0..50°C

The KIT includes: 1 sachet x 25 ml 1413 µS and 12,88 mS buffer solution, lanyard, tissues, quick manual and cardboard case.



Name	Description	p/n
COND 1 KIT	COND 1 Kit complete	50014163
COND 1 ECOPACK	COND 1, batteries 1,5 V AAA, lanyard, quick manual	50014153

pH 5

○ pH - mV - T

IP67 watertight portable pH meter. Resolution 0,01 pH, with microprocessor and interchangeable electrode, temperature sensor and open partitions. **Wide 3-colour LCD display with indication of the buffers used for calibration and measurement stability.** Push-button calibration on 3 points with 5 values of USA buffers. mV reading for pH electrode diagnosis or for ORP sensor connection. **Temperature reading.** Auto power off function. **Automatic temperature compensation (0...60 °C).** Self-diagnosis messages: low batteries, calibration errors. Power supply with 2 x 1.5V AAA batteries included, compatible with rechargeable batteries too. 1 year warranty on electronic parts.

Measuring range: pH: -2,00...16,00 (Resolution 0,01 pH); mV: -1.000...+1.000 mV; °C: 0,0...60,0 (0,1 °C).

The KIT includes: 1 sachet x 25ml pH 7 and pH 4 buffer solutions, 1 sachet of electrode storage solution, calibration cap, lanyard, tissues, quick manual and cardboard case.



Name	Description	p/n
pH 5 KIT	pH 5 Kit complete	50014063
pH 5 ECOPACK	pH 5, batteries 1,5 V AAA, storage, lanyard and quick manual	50014053
pH 5 ONLY BODY	pH 5, without sensor	50014073
ELECTRODE pH	Replacement electrode for pH 5	50014403

pH 5 Food

○ pH - mV - T

IP67 watertight portable pH meter. Resolution 0,01 pH, with microprocessor and interchangeable polymer-tipped electrode, temperature sensor and open partitions for **measurements in the food industry.** **Wide 3-colour LCD display with indication of the buffers used for calibration and measurement stability.** Push-button calibration on 3 points with 5 values of USA buffers. mV reading for pH electrode diagnosis. **Temperature reading.** Auto power off function. **Automatic temperature compensation (0...60 °C).** Self-diagnosis messages: low batteries, calibration errors. Power supply with 2 x 1.5V AAA batteries included, compatible with rechargeable batteries too. 1 year warranty on electronic parts.

Measuring range: pH: -2,00...16,00 (Resolution 0,01 pH); mV: -1.000...+1.000 mV; °C: 0,0...60,0 (0,1 °C).

The KIT includes: 1 sachet x 25ml pH 7 and pH 4 buffer solutions, 1 sachet of electrode storage solution, calibration cap, lanyard, tissues, quick manual and cardboard case



Name	Description	p/n
pH 5 Food KIT	pH 5 Food Kit complete	50014113
pH 5 Food ECOPACK	pH 5 Food with batteries 1,5 V AAA, storage, lanyard and quick manual	50014123
ELECTRODE pH	Replacement electrode for pH 5 Food	50014423

COND 5

○ Conductivity - TDS - Salinity - T

IP67 watertight portable conductivity meter for Conductivity, TDS and Salinity measurement. Automatic scale change.

With microprocessor and high-durable interchangeable electrode. **Wide 3-color LCD display** with indication of the buffers used for calibration and measurement stability. Push-button calibration on 3 points with 3 standard values, choosing between 84, 1413 μ S and 12,88 mS. Reading and automatic temperature compensation with TR= 20/25 °C and adjustable coefficient TC= 0,00...4,00%/°C. TDS Factor: 0,40...1,00. Self-diagnosis messages. Power supply with 2 x 1.5V AAA batteries included, compatible with rechargeable batteries too.

Auto power off function.

1-year warranty on electronic parts.

Measuring range: COND 0,01 μ S...200 mS; TDS 0,01 ppm...199,9 ppt; Salinity 0,1mg/l...100,0 g/l.

The KIT includes: 1 sachet x 25ml 1413 μ S and 12,88 mS buffer solutions, calibration cap, lanyard, tissues, quick manual and cardboard case.



Tester

Name	Description	p/n
COND 5 KIT	COND 5 Kit complete	50014213
COND 5 ECOPACK	COND 5, batteries 1,5 V AAA, lanyard and quick manual	50014203
COND 5 ONLY BODY	COND 5, without sensor	50014223
SENSOR COND	Replacement sensor for COND 5	50014413
VPT SOIL COND 5	Conductivity cell with temperature probe, C = 1, fo ground measurement, working range 10 μ S ... 50 mS, cable 1.5 m for COND 5	50014713

ORP 5

○ Redox - T

IP67 watertight portable ORP/Redox meter. **Resolution** 0,1/1 mV. With microprocessor and interchangeable **high-durable electrode**. **ORP calibration** on one point decided by the user.

Wide 3-color LCD display with indication of measurement stability. Auto power off function.

Temperature reading. Self-diagnosis messages. Power supply with 2 x 1,5V AAA batteries included, compatible with rechargeable batteries too.

1 year warranty on electronic parts.

Measuring range: mV: -1.000...+1.000 mV; °C: 0,0...60,0 (0,1°C).

The KIT includes: : 1 bottle x 55ml Redox 475 mV solution, 1 sachet of electrode storage solution, calibration cap, lanyard, tissues, quick manual and carboard case.



Name	Description	p/n
ORP 5 KIT	ORP 5 Kit complete.	50014313
SENSOR REDOX	Replacement sensor for ORP 5	50014443

PX 4

○ pH - Redox - T

MAIN FEATURES

IP67 watertight portable pH and ORP/Redox meter. Resolution 0,01 pH and 0,1 / 1 mV. With microprocessor and interchangeable combined electrode. **Wide 3-colour LCD display** with indication of the buffers used for calibration and measurement stability. **pH automatic calibration** on 3 points with 5 values of USA buffers and **ORP calibration** on 1 point decided by user. **mV reading for pH electrode diagnosis** and ORP/Redox measurement. **Temperature reading**. Auto power off function. **Automatic temperature compensation** (0...60 °C). Self-diagnosis messages: low batteries, calibration errors. Power supply with 2 x 1.5V AAA batteries included, compatible with rechargeable batteries too. 1 year warranty on electronic parts.

Measuring range: pH: -2,00...16,00 (0,01 pH); mV: -1.000...+1.000 mV; °C: 0,0...60,0 (0,1 °C).

The KIT includes: 1 sachet x 25ml pH 7 and pH4 buffer solutions, 1 bottle x 55ml Redox 475 mV, 1 sachet of electrode storage solution, calibration cap, lanyard, tissues, quick manual and cardboard case.



Name	Description	p/n
PX 4 KIT	PX 4 Kit complete	50014143
PX 4 ECOPACK	PX 4 , batteries 1,5 V AAA, storage, lanyard and quick manual	50014173
ELECTRODE pH + REDOX	Replacement sensor for PX 4	50014463

PC 5

○ pH - Conductivity- TDS - Salinity -T

MAIN FEATURES

IP67 watertight portable multiparameter for pH, Conductivity, TDS and Salinity measurement. **Interchangeable combined electrode**. Indication of the buffers used for calibration and measurement stability. Self-diagnosis messages. Power supply with 2 x 1.5V AAA batteries included, compatible with rechargeable batteries too.

Auto power off function.

1 year warranty on electronic parts.

pH: Resolution 0,01 pH. Push-button calibration on 3 points with 5 values of USA buffers.

mV reading for pH electrode diagnosis.

COND: Push-button calibration on 3 points with 3 standard values, choosing between 84, 1413 μS e 12,88 mS. Adjustable coefficient TC= 0,00...4,00%/°C.

TDS Factor: 0,40...1,00.

Measuring range:

pH: -2,00...16,00 (0,01 pH);

mV: -1.000...+1.000 mV;

COND 0,01 μS...200 mS;

TDS 0,01 ppm...199,9 ppt;

Salinity 0,1mg/l...100,0 g/l;

T: 0,0...60,0°C (0,1 °C).

The KIT includes: 1 sachet x 25ml pH 7 and pH 4 buffer solutions, 1 sachet of electrode storage, 1 sachet x 25ml 1413 μS buffer solution, calibration cap, lanyard, tissues, quick manual and cardboard case.



Name	Description	p/n
PC 5 KIT	PC 5 Kit complete	50014263
PC 5 ECOPACK	PC 5 , batteries 1,5 V AAA, storage, lanyard and quick manual	50014253
ELECTRODE PC	Replacement electrode for PC 5	50014433

PC 6

○ pH -Redox - Conductivity- TDS - Salinity - T

MAIN FEATURES

IP67 watertight portable multiparameter for pH, ORP, Conductivity, TDS and Salinity measurement. High-durable interchangeable combined electrode. **Wide 3-colour LCD display** with **indication of the buffers used for calibration** and measurement stability. Reading and **automatic temperature compensation** (0...60°C). Auto power off function. Self-diagnosis messages: low batteries, calibration errors. Power supply with 2 x 1.5V AAA batteries included, compatible with rechargeable batteries too. 1 year warranty on electronic parts.

pH: Resolution 0,01 pH. Automatic calibration on 3 points with 5 values of USA buffers and . ORP calibration on one point decided by the user.

mV reading for pH electrode diagnosis and ORP/Redox measurement.

COND: Automatic calibration on 3 points with 3 standard, choosing between 84, 1413 µS e 12,88 mS.

Automatic temperature compensation with TR= 20/25°C and adjustable coefficient TC= 0,00...4,00%/°C. **TDS** factor: 0,40...1,00.



Tester

Measuring range :

pH: -2,00...16,00 (0,01 pH);

mV: -1.000...+1.000 mV;

COND 0,01 µS...200 mS;

TDS 0,01 ppm...199,9 ppt;

Salinity 0,1mg/l...100,0 g/l;

°C: 0,0...60,0°C (0,1 °C).

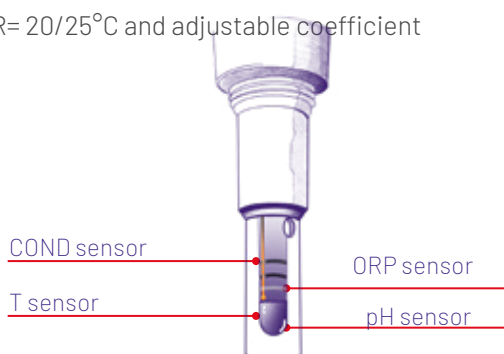

The KIT includes: 1 sachet x 25 ml pH 7 and pH 4 buffer solutions, 1 sachet x 25 ml storage solution and 1413 µS standard solution, calibration cap, lanyard, tissues, quick manual and cardboard case.

Name	Description	p/n
PC 6 KIT	PC 6 Kit complete	50014293
ELECTRODE PC	Replacement electrode for PC 6	50014483

CALIBRATION BUFFER SOLUTIONS

Name	Description	p/n
pH 4,01	1 bottle x 55 ml buffer solution. Accuracy ±0,01 pH	32383123
pH 7,00	1 bottle x 55 ml buffer solution. Accuracy ±0,01 pH	32383133
475 mV	1 bottle x 55 ml buffer solution for REDOX	32383153
1413 µS	1 bottle x 55 ml buffer solution	60000423
12 880 µS	1 bottle x 55 ml buffer solution	60000433
84 µS	1 bottle x 55 ml buffer solution	60000613

NOTE



BALANCES



WARRANTY
2
YEARS



★ ★ ★ ★ ★
EU ★ ★ ★ ★ ★
Designed

ISO 9001
CERTIFIED

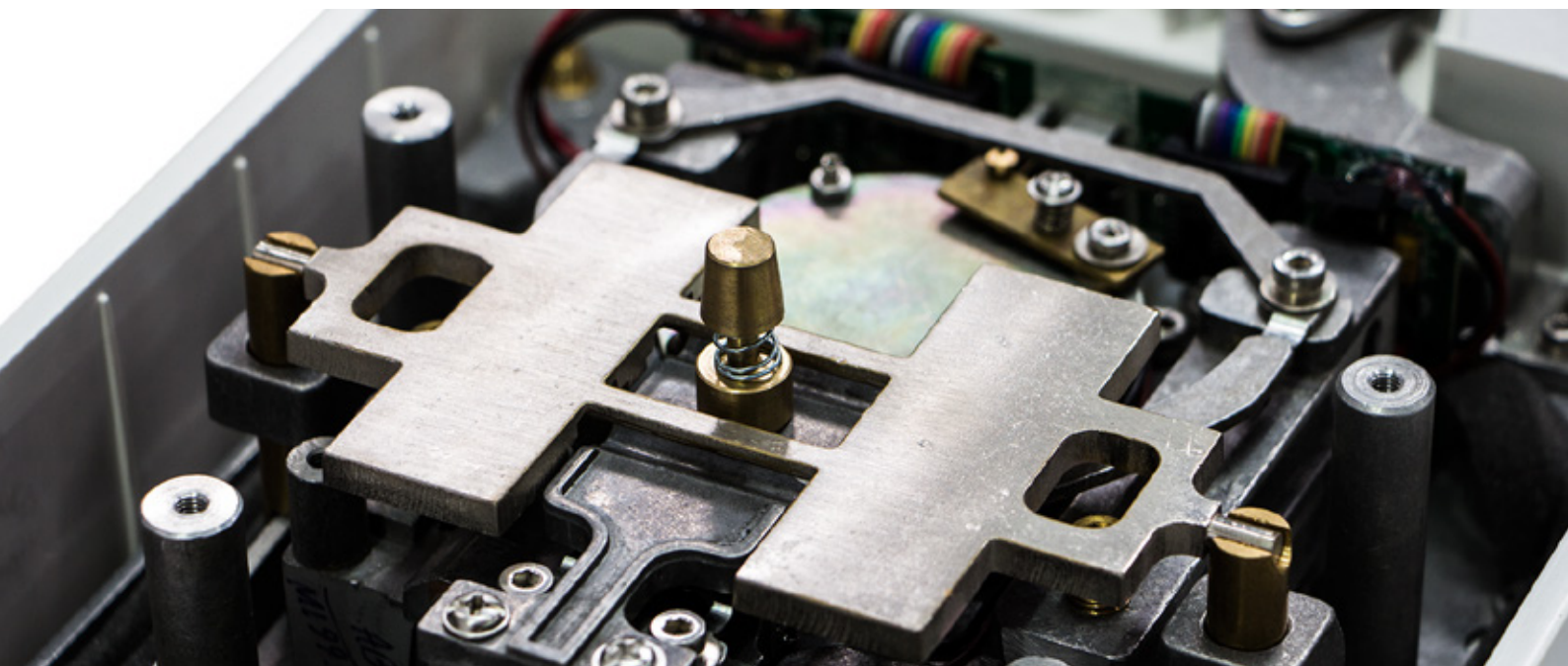

HOW TO CHOOSE

Resolution (g)	Capacity (g)	Model	Calibration	RS-232	Batteries	p/n
0,0001	220	BL 224 TOUCHSCREEN	Internal + External	●		27006013
0,0001	220	BL 224	Internal + External	●		27006003
0,0001	220	BL 224 BASIC	External	●		27005993
0,001	300	BL 303	External	●	●	27000513
0,001	110	BM 113 MOISTURE ANALIZER	External	●		27001303
0,01	600	BL 602	External	●	●	27000323
0,01	2.000	BL 2002 BASIC	External		●	27000303
0,01	2.000	BL 2002	External	●	●	27000313
0,1	3.000	BL 3001	External	●	●	27000113
0,1	6.000	BL 6001 BASIC	External		●	27000293
0,1	6.000	BL 6001	External	●	●	27000123
0,1	30.000	BL 30K1	External		●	27000133
1	3.000	BW 3000 WATERPROOF	External		●	27001003
1	30.000	BL 30K	External	●	●	27001203
10	100.000	BL 100K	External	●		27001213

BL 224 TOUCH

- Touchscreen graphic display
- Capacity: 220 g
- Resolution: 0,0001 g (0,1 mg)

Analytical, digital scale of precision. Stainless steel plate. Protection case against air currents in laboratory. Upper opening for pipetting without removing the case.

Standard RS 232 output for connection to PC or printer.

Provided with standard 220V power supply.

Supplied with external standard weight for calibration 200 g - F1 class.

Supplied with Certificate of calibration made with weights certified Accredia, including test of repeatability, linearity and off-centre load.



Name	Calibration	Ø Plate (mm)	Repeatability (g)	Linearity (g)	p/n
BL 224 TOUCHSCREEN	INTERNAL + EXTERNAL	80	± 0,0002	± 0,0005	27006013

BL 224

- Capacity: 220 g
- Resolution: 0,0001 g (0,1 mg)

Analytical, digital scale of precision. Backlit display. Stainless-steel plate. Protection case against air currents in laboratory. Upper opening for pipetting without removing the case. Piece counter mode, determination of %, formulations, pipette calibration function, statistics and density calculation (with optional accessory kit).

Standard RS 232 output for connection to PC or printer.

Provided with standard 220V power supply.

Supplied with Certificate of calibration made with weights certified Accredia, including test of repeatability, linearity and off-centre load.



Name	Calibration	Ø Plate (mm)	Repeatability (g)	Linearity (g)	p/n
BL 224	INTERNAL + EXTERNAL	90	± 0,0001	± 0,0002	27006003

BL 224 BASIC

- Capacity: 220 g
- Resolution: 0,0001 g (0,1 mg)

Analytical, digital scale of precision. Backlit display. Stainless-steel plate. Protection case against air currents in laboratory. Upper opening for pipetting without removing the case. Standard RS 232 output for connection to PC or printer. Standard 220V power supply.

Supplied with external standard weight for calibration 100 g - E2class.

Supplied with **Certificate of calibration made with weights certified Accredia, including test of repeatability, linearity and off-centre load.**



Name	Calibration	Ø Plate (mm)	Repeatability (g)	Linearity (g)	p/n
BL 224 BASIC	EXTERNAL	90	± 0,0003	± 0,0003	27005993

BL 303

- Capacity: 300 g
- Resolution: 0,001 g (1 mg)

Backlit display. Round plate with diameter 118 mm in stainless-steel.

Protection case against air currents in laboratory.

Upper opening for pipetting without removing the case.

Piece counter mode, determination of % and 21 different selectable measurement units.

Scale with dual power supply, AGM rechargeable battery and standard power supply.

Standard RS 232 output for connection to PC or printer.

Supplied with case and a weight of 100 g M1 class.

Provided with Certificate of calibration with weights Accredia certified, including test of repeatability, linearity and off-centre load.



Name	Calibration	Ø Plate (mm)	Repeatability (g)	Linearity (g)	p/n
BL 303	EXTERNAL	118	± 0,002	± 0,002	27000513

BL 602

- Capacity: 600 g
- Resolution: 0,01 g



Technical, digital scale of precision. Backlit Display.

Round plate with diameter 118 mm in stainless-steel.

Protection case, easily removable, ideal for counting small pieces, protected from external disturbances.

Upper opening for pipetting without removing the case.

Piece counter mode, determination of % and 21 different selectable measurement units. Balance with dual power supply, AGM rechargeable battery standard power supply.

Standard RS 232 output for connection to PC or printer.

Supplied with case and 2 standard weights of 100 g M1 class.

Name	Calibration	Ø Plate (mm)	Repeatability (g)	Linearity (g)	p/n
BL 602	EXTERNAL	118	± 0,01	± 0,01	27000323

BL 2002

- Capacità: 2000 g
- Risoluzione: 0,01 g



Technical, digital scale of precision. Backlit Display.

Rectangular stainless-steel plate.

Piece counter mode, determination of % and 21 different selectable measurement units.

Scale with dual power supply, AGM rechargeable battery and standard power supply.

Standard RS 232 output for connection to PC or printer.

Supplied with dust protection cover and a standard weight of 1 Kg M1 class.

Name	Calibration	Ø Plate (mm)	Repeatability (g)	Linearity (g)	p/n
BL 2002	EXTERNAL	188 x 148	± 0,02	± 0,02	27000313

BL 3001 / 6001

- Capacity: 3 Kg / 6 Kg
- Resolution: 0,1g



Technical, digital scale of precision. Backlit Display.
 Rectangular stainless-steel plate mm 188 x 148.
 Piece counter mode, determination of % and 21 different selectable measurement units. Balance with dual power supply, AGM rechargeable battery and standard power supply.
 Standard RS 232 output for connection to PC or printer.
 Supplied with dust protection cover and a standard weight of 1 Kg M1 class.

Name	Calibration	Ø Plate (mm)	Repeatability (g)	Linearity (g)	p/n
BL 3001	EXTERNAL	188 x 148	± 0,2	± 0,2	27000113
BL 6001	EXTERNAL	188 x 148	± 0,2	± 0,2	27000123

BL BASIC : 2002 / 6001

- The cheapest
- Capacity: 2000 g / 6000 g
- Resolution: 0,01 g / 0,1g



Technical, digital scale of precision with backlit Display.
 Rectangular stainless-steel weighing plate.
 Piece counter mode.
 Scale with dual power supply, AGM rechargeable battery and standard power supply.

Name	Calibration	Ø Plate (mm)	Repeatability (g)	Linearity (g)	p/n
BL 2002 BASIC	EXTERNAL	160 x 120	± 0,02	± 0,02	27000303
BL 6001 BASIC	EXTERNAL	143 x 192	± 0,2	± 0,2	27000293

Scales

BL 30K 1

- Capacity: 30 Kg
- Resolution: 0,1 g

Technical, digital scale of precision with backlit Display.
Rectangular stainless-steel weighing plate.
Piece counter mode, determination of % and different selectable measurement units.
Scale with dual power supply, AGM rechargeable battery and standard power supply.



Name	Calibration	Ø Plate (mm)	Repeatability (g)	Linearity (g)	p/n
BL 30K 1	EXTERNAL	330 x 260	± 0,2	± 0,2	27000133

BL 30K

- Capacity: 30 Kg
- Resolution: 1 g

Technical, digital scale of precision.
Rectangular stainless-steel weighing plate.
Piece counter mode, determination of % and different selectable measurement units.
Scale with dual power supply, AGM rechargeable battery and standard power supply.
Standard RS 232 output for connection to PC or printer.



Name	Calibration	Ø Plate (mm)	Repeatability (g)	Linearity (g)	p/n
BL 30K	EXTERNAL	255 x 190	± 1	± 3	27001203

BL 100K

- Capacity: 100 Kg
- Resolution: 10 g

Technical, digital scale of precision.
Removable backlit Display.
Rectangular stainless-steel weighing plate.
Piece counter mode, determination of % and different selectable measurement units.
Standard 220V power supply.



Name	Calibration	Ø Plate (mm)	Repeatability (g)	Linearity (g)	p/n
BL 100K	EXTERNAL	300 X 400	± 10	± 5 g (0..5 Kg); ± 10 g (5..20 Kg); ± 15 g (20..100 Kg)	27001213

BM 113 MOISTURE ANALYSER

- Capacity: 110 g
- Resolution: 0,001g



Precision thermoscale. Backlit Display.
 Stainless steel round weighing plate with an external diameter of 90 mm.
 GLP protocol.
 Internal memory for automatic sequence of 15 drying programs.
 Three drying methods: Soft, Standard, Fast.
 Three switch-off methods: Auto, Manual, Timer.
 400W Halogen lamp.
 Standard RS 232 output for connection to PC or printer.
 Supplied with: standard weight of 100 g for calibration and control, 50 aluminium plates, calibration report, including test of repeatability, linearity, off-centre load and temperature check.

Name	Calibration	Ø Plate (mm)	Repeatability (g)	Linearity (g)	p/n
BM 113	EXTERNAL	90	40 ... 199 °C	1 ... 99 min	27001303
PLATES	Single use aluminium plates with external diam. 90 mm, 1 pack x 50 pieces				27000883

BW 3000 WATERPROOF



- Capacity: 3000 g
- Resolution: 1 g
- IP67
- Double display



IP67 watertight digital precision technical scale.
 Dual display, one on the front and one in the back, very useful for assembly line work.
 Stainless steel rectangular weighing plate with dimensions 220 x 180 mm.
 Piece counter mode, determination of %
 Metal outer case
 Scale with dual power supply, AGM rechargeable battery and standard power supply.

Name	Calibration	Ø Plate (mm)	Repeatability (g)	Linearity (g)	p/n
BW 3000	EXTERNAL	225 x 185	±1	± 1	27001003

ACCESSORIES

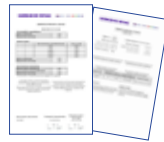
Name	Description		p/n
COVER	Protective cover for XS BALANCE compatible with the models: BL602, BL2002, BL3001, BL6001.		27000803
PRINTER RS 232	Thermal paper printer for XS BALANCE with RS 232 output.		27000863
CERTIFICATE	Accredited Calibration certificate Accredia for XS BALANCE. To be ordered together with the balance (when not already included)		27000873
WEIGHT 100 g	Weight 100 g in class M1 for XS Balances		27000813
WEIGHT 1Kg	Weight 1000 g in class M1 for XS Balances		27000823

CALIBRATION REPORT

The certificate is filled in at Giorgio Bormac's company. Certificated Accredia weights are used for testing the scales.

On the Certificate are reported the test results of:

- **REPEATABILITY**
- **LINEARITY**
- **DECENTRED LOAD**
- **TEMPERATURE CHECK (only BM 113)**

According to Accredia guidelines for balance calibration

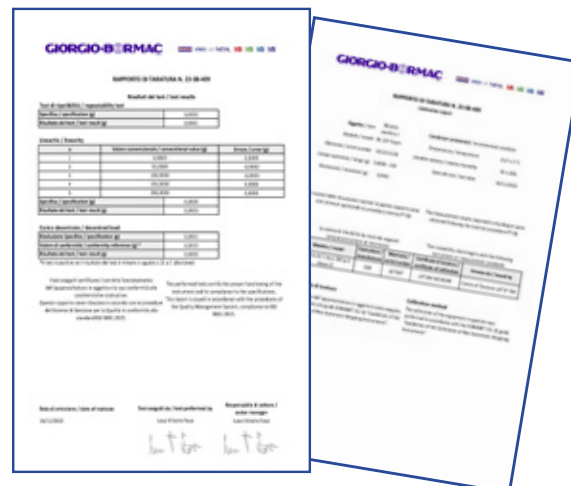

CENTRIFUGES

NEYA
by XS

WARRANTY
2
YEARS



★ ★ ★ ★ ★
EU ★ ★ ★ ★ ★
Designed

ISO certified
manufacturer



HOW TO IDENTIFY THE ACCESSORIES

FIRST LETTER

A = Fixed angle rotor
S = Swing out rotor
B = Bucket
SB = Swing out rotor + Buckets (KIT)
L = Lid of bucket
I = Insert for bucket
C = Cushion
RE = Reductor
T = Tube
PCR = PCR rotor

CENTRAL NUMBERS*

1° NUMBER = maximum number of tubes
2° NUMBER = capacity of the tube (ml)

Only in the reducers (RE), the central numbers identify the capacity reduction (ml); in case of only one central number, it represents the capacity.
In the PCR rotor the central numbers identify the number of PCR strips and the number of tubes for each single strip.

FINAL LETTER

F = Falcon® tube or conical bottomed tube included
P = Plastic round-bottomed tube included
G = Glass round-bottomed tube included
R = Suitable for round-bottomed tube
X = Additional bucket (long version)

- A 32-15 N** Fixed-angle rotor for 32 – 15 ml tubes
S 4-175 Swing out rotor for 4 buckets of 175 ml
B 16-5/7 Aluminium bucket for 16 tubes of 5/7 ml
SB 4-175 Kit composed by swing out rotor S 4-175 and 4 glasses B 175 of 175 ml
I 4-15R Insert for 4 round-bottomed tubes of 15 ml
RE 50-15F Conical bottomed reductor from 50 ml to 15 ml
B 50XF Test tube rack extra version with Falcon® test tube 50 ml

CENTRIFUGING

The centrifuges are instruments used in many laboratories to separate particles in liquid solutions or in liquids with a different density, using an artificial centrifugal field. The application of the centrifuges allows to develop a much higher force than the Earth's gravity, speeding-up the separation and sedimentation process.

SWING OUT ROTORS (with variable angle)

During the centrifugation, the tubes turn into a perpendicular position with respect to the rotation axis of the rotor. Therefore, the distance and the time necessary for the sedimentation are higher, but the phases limits develop clearly and perpendicular. The swing out rotors are generally used to centrifuge a bigger quantity of samples at medium speed.

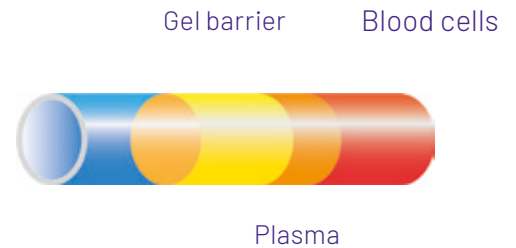

ANGLE ROTORS (with fixed angle)

The oblique angle of the tubes reduces the sedimentation distance, decreasing the necessary time for the separation of the phases, that are inclined with respect to the tube and less net. The angle rotors are generally used to centrifuge a smaller quantity of samples at high speed.

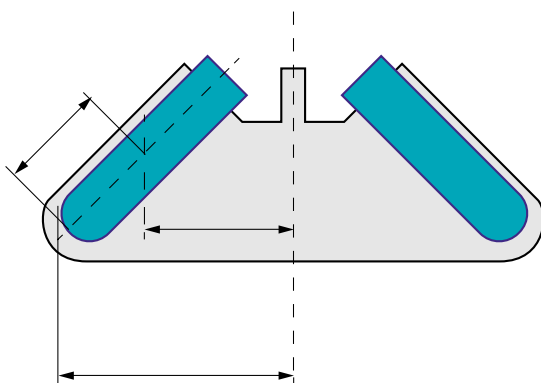
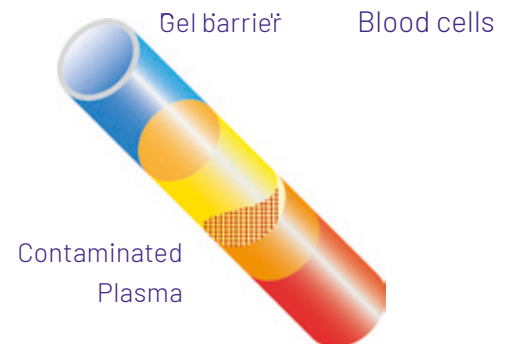

The simplified formula for the RCF is:

$$RCF = (n/1000)^2 \times r \times 11,18$$
 where n = speed (rpm) and r = ray in cm

CALCULATION OF THE CENTRIFUGAL FORCE

Generally, the performances of a centrifuge are indicated following the maximum achievable speed. However, the speed indicates approximately the real force which developed in the centrifuged sample and which generates the separation. This power expresses as Relative Centrifugation Force (RCF). Its value indicates the multiple of times that the force exceeds the acceleration caused from the gravity "g". Looking at the formula here on the left, the RCF is directly proportional to the ray of the rotor and linked to the square of the speed. This means that the RCF doubles if the ray doubles and quadruples if the speed doubles.

Therefore, the performances of the centrifuges should be compared on values expressed in RCF only.

NEYA 8 Basic

- Maximum loading capacity: 4x175 ml
- Maximum speed: 6000 rpm
- Automatic rotor detection
- Control of the maximum speed of the rotor
- Safety speed limiter function
- Backlit colour LCD display



Ventilated benchtop centrifuge with **automatic rotor detection**, check of presence of accessories and of allowed max. speed.

Speed limiter for laboratory safety. Display of all centrifugation parameters on a single screen. Low number of keys, adjustment handle with confirming function and guide for an extremely intuitive operativity. Equipped with brushless motor, maintenance free and silent.

Programmable speed from 500 to 6000 rpm (subjected to the placed rotor) with step of 50 rpm. Centrifugation time from 00:30 to 99:50 (mm:ss) with increases in 10 seconds or constantly function. Acceleration and deceleration adjustable on 3 levels.

Automatic locking system of the lid with possibility to recover the tubes in case of electric power absence. **Imbalance detection system** with automatic functioning stop.

The centrifuge follows the directives EN61010-1; EN61010-2-020; EN61326-1. Compact sizes to optimize the space in laboratory. **The room access height of only 27,5 cm makes the loading and unloading operation of the centrifuge easy.**

Power supply: 220V, 50 Hz.
Max. noisiness: 55 dB

Centrifuges

Name	Max load	Max speed.	External dimensions (L x W x H)	Weight	p/n
NEYA 8 WITHOUT ROTOR	4 x 175 ml	6000 rpm	45 x 59 x 33 cm	40 Kg	40100302

NEYA 10 Professional

- Maximum loading capacity: 4x175 ml
- Maximum speed: 6000 rpm
- Automatic rotor detection
- Max speed control
- Safety speed limiter function
- Backlit display multicolor LCD



Ventilated benchtop centrifuge with **automatic rotor detection**, check of presence of accessories and of allowed max. speed.

Speed limiter for laboratory safety. Display of all centrifugation parameters on a single screen.

Low number of keys, adjustment handle with confirming function and guide for an **extremely intuitive operativity.**

Equipped with brushless motor, maintenance free and silent.

Programmable speed from 500 to 6000 rpm (subjected to the placed rotor) with step of 50 rpm. Centrifugation time from 00:30 to 99:50 (mm:ss) with increases in 10 seconds or constantly function.

Acceleration and deceleration adjustable on 3 levels.

Automatic locking system of the lid with possibility to recover the tubes in case of electric power absence.

Imbalance detection system with automatic functioning stop.

The centrifuge follows the directives **EN61010-1; EN61010-2-020; EN61326-1.**

Compact sizes to optimize the space in laboratory
The room access height of only 27,5 cm makes the **loading and unloading operation of the centrifuge easy.**

Power supply: 220V, 50 Hz.

Max. noisiness: 55 dB

NEYA 10 R

REFRIGERATED VERSION

Adjustable temperature from -10 °C to +40 °C (from +14 to +104 °F) with increases and decreases of 1 °C (or 1 °F).

“Precool” function for the fast cooling of the centrifuge

Power supply: 220V, 50 Hz.

Max. noisiness: 55 dB



Name	Max load	Max speed	External dimensions (L x W x H)	Weight	p/n
NEYA 10 WITHOUT ROTOR	4 x 175 ml	6000 rpm	45 x 59 x 33 cm	40 Kg	40100312
NEYA 10 R WITHOUT ROTOR	4 x 175 ml	6000 rpm	73 x 64 x 33 cm	70 Kg	40100332

NEYA 16 High Speed

- Maximum loading capacity:: 4x175 ml
- Maximum speed: 16000 rpm
- Automatic rotor detection
- Max speed control
- Safety speed limiter function
- Backlit display multicolor LCD



Ventilated or refrigerated centrifuge (CFC-free), with **automatic rotor detection**, check of presence of accessories and of allowed max. speed.
Speed limiter for laboratory safety. Display of all centrifugation parameters on a single screen. .

Low number of keys, adjustment handle with confirming function and guide for an extremely intuitive operativity.
 Equipped with brushless motor, maintenance free and silent.

Programmable speed from 500 to 16000 rpm (subjected to the rotor placed) with step of 50 rpm.
RCF adjustable up to 21000 xg (subjected to the placed rotor).
 Centrifugation time from 00:30 to 99:50 (mm:ss) with increases in 10 seconds or constantly function.
 Acceleration and deceleration adjustable on 10 levels.
10 Programs with overwriting security system.

Centrifugal function **SPIN**.
Acoustic and lighting end-of-centrifugation warning.
Automatic locking system of the lid with possibility to recover the tubes in case of electric power absence.
 Imbalance detection system with automatic functioning stop.
 The centrifuge follows the directives **EN61010-1; EN61010-2-020; EN61326-1.**
 Compact sizes to optimize the space in laboratory
 The room access height of only 27,5 cm makes the **loading and unloading operation of the centrifuge easy.**

Max. noisiness: 55 dB
 Power supply: 220V, 50 Hz.
 Warranty: 24 months

NEYA 16 R

REFRIGERATED VERSION

Adjustable temperature from -10 °C to +40 °C (from +14 to +104 °F) with increases and decreases of 1 °C (or 1°F).
 "Precool" function for the fast cooling of the centrifuge.



Name	Max load	Max speed	External dimensions (L x W x H)	Weight	p/n
NEYA 16 WITHOUT ROTOR	4 x 175 ml	16000 rpm	45 x 59 x 33 cm	40 Kg	40100322
NEYA 16R WITHOUT ROTOR	4 x 175 ml	16000 rpm	73 x 64 x 33 cm	70 Kg	40100342

















Centrifuges

SWING OUT ROTORS

Name	Description	p/n
SB 4-175 KIT	Kit includes : Swing out rotor S 4-175 , maximum capacity 4 x 175 ml. Maximum speed 4.500rpm, RCF max. 3600xg. 4 buckets B 175 4 Biosafe lids L 175	40100502
L 175 SPARE PART COVER	Biosafe lid for bucket B 175.	40101522
B 175 SPARE PART GLASS	Aluminium bucket of 175 ml for rotor S 4-175.	40101512



HOW TO CHOOSE THE INSERT CONSIDERING THE TUBE

							
I 12-2	Ø ≤ 10,6 mm H ≤ 42 mm	I 7-5/7	Ø ≤ 13 mm H ≤ 116 mm	I 7-10	Ø ≤ 16 mm H ≤ 114 mm	I 4-15F	Ø ≤ 17 mm H ≤ 120 mm
							
I 4-15R	Ø ≤ 17 mm H ≤ 110 mm	I 1-50 SF	Ø ≤ 29 mm H ≤ 116 mm	I 1-50R	Ø ≤ 30 mm H ≤ 110 mm	I 1-100	Ø ≤ 46 mm H ≤ 102 mm

INSERTS FOR BUCKETS B 175 – KIT OF 4 PIECES - Tubes not included

Name	Description	Max Tubes	p/n
I 12-2	Kit of inserts (12 tubes each) of 1,5-2 ml type Eppendorf®	48	40100602
I 7-5/7	Kit of inserts (7 tubes each) from levy Vacutainer® of 5-7 ml. (Ø x L) 13x75 and 13x100 mm.	28	40100612
I 7-10	Kit of inserts (7 tubes each) from levy Vacutainer® of 10 ml. (Ø x L) 16x100 mm	28	40100622
I 4-15 F	Kit of inserts (4 tubes each) with conical bottom type Falcon® of 15 ml. (Ø x L) 17x120 mm	16	40100632
I 4-15 R	Kit of inserts (4 tubes each) with round bottom of 15 ml (Ø x L) 17x110 mm	16	40100642
I 1-50 SF	Kit of inserts (1 tube each) with conical bottom type Falcon® of 50 ml (Ø x L) 29x116 mm. The insert is suitable with conical bottomed self-standing tubes.	4	40100682
I 1-50 R	Kit of inserts (1 tube each) with round bottomed of 50 ml. (Ø x L) 30x110 mm	4	40100662
I 1-100	Kit of inserts (1 tube each) with round bottomed of 100 ml. (Ø x L) 46x102 mm	4	40100672

TUBES

Name	Description	p/n
T 15F	Plastic tube type Falcon® of 15 ml (Ø x L) 17 x 120 mm	40003402
T 15G	Glass round bottomed tube of 15 ml (Ø x L) 17 x 110 mm (max. speed 3000 rpm)	40003412
T 15P	Plastic round bottomed tube of 15 ml (Ø x L) 17 x 102 mm	40003422
T 50F	Plastic tube type Falcon® of 50 ml (Ø x L) 29 x 116 mm	40003432
T 50G	Glass round bottomed tube of 50 ml (Ø x L) 30 x 110 mm (max. speed 3000 rpm)	40003442
T 50P	Plastic round bottomed tube of 50 ml (Ø x L) 30 x 100 mm	40003452
T 100G	Glass round bottomed tube of 100 ml (Ø x L) 46 x 102 mm (max. speed 3000 rpm)	40003462
T 100P	Plastic round bottomed tube of 100 ml (Ø x L) 46 x 100 mm	40003472
T 175	Plastic tube with round bottom of 175 ml with screw lid (Ø x L) 57 x 97 mm	40003492

SWING OUT ROTORS

Name	Description	p/n
S 4-175 ONLY ROTOR	Swing out rotor maximum capacity 4 x 175 ml for aluminium carrier and buckets. Max. speed 4.500rpm, RCF max. 3.600 xg.	40101502
S 6-96 MP PLATES INCLUDED	Swing out rotor for microplates, maximum capacity of 6 plates of 96 wells. Maximum speed 3.200rpm, RCF max. 1.950 xg. Supplied with 2 trays.	40100522

S 4-175
ONLY ROTOR



S 6-96 MP
PLATES INCLUDED





CARRIERS FOR SWING OUT ROTOR S 4-175

Set of 4 pieces.

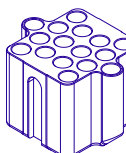
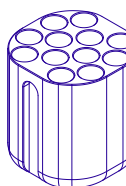
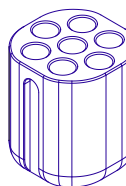
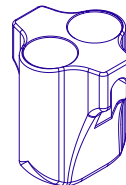
Name	Description	Max n° of tubes	p/n
NEW B 2-50 F	Carrier for 2 conical bottomed tube type Falcon® of 50 ml (Ø x L) 29x116 mm.	8	40101532
NEW B 2-50 R	Carrier for 2 round bottomed tubes of 50 ml (Ø x L) 30x110 mm .	8	40101582
NEW B 7-15 F	Carrier for 7 conical bottomed tubes type Falcon® of 15 ml (Ø x L) 17x120 mm.	28	40101542
NEW B 7-15 R	Carrier for 7 round bottomed tubes of 15 ml (Ø x L) 17x110 mm.	28	40101592
NEW B 12-10	Carrier for 12 collection tubes Vacutainer® of 10 ml (Ø x L) 16x110 mm.	48	40101552
NEW B 14-5/7	Carrier for 14 collection tubes Vacutainer® of 5-7 ml (Ø x L) 13x100 mm.	56	40101562
NEW B 16-5/7	Carrier for 16 collection tubes Vacutainer® of 5-7 ml (Ø x L) 13x75 mm.	64	40101572



HIGH CAPACITY FIXED ROTORS

Name	Description	Max. speed.	RCF max (xg)	n° of tubes max	p/n
A 32-15 N	 37° fixed angle rotor for 15 ml tubes	5200	4020	32	40100802
A 8-50	 37° fixed angle rotor for 50 ml tubes	6000	4800	8	40100812
A 6-100	 37° fixed angle rotor for 100 ml tubes	5000	3330	6	40100822





All the rotors are supplied without buckets.

BUCKETS- FOR HIGH CAPACITY ROTORS – TUBES INCLUDED

For rotor	Name	Description	p/n
A 32-15 MIN. 32 PCS	B 15 F	For conical bottomed tubes of 15 ml. Complete with Falcon® tube of 15 ml. (Ø x L) 17x120 mm	40101002
	B 15 G	For round bottomed tubes of 15 ml. Complete with glass tube of 15 ml. (Ø x L) 17x110 mm	40101012
	B 15 P	For round bottomed tubes of 15 ml. Complete with plastic tube of 15 ml. (Ø x L) 17x102 mm	40101022
A 6-50 MIN. 6 PCS	B 50 XF	for conical bottomed tubes of 50 ml. Complete with Falcon® tube of 50 ml (Ø x L) 29x116 mm	40101032
	B 50 XG	for round bottomed tube of 50 ml. Complete with glass tube of 50 ml (Ø x L) 30x110 mm	40101042
A 8-50 MIN. 8 PCS	B 50 XP	for round bottomed tubes of 50 ml. Complete with plastic tube of 50 ml. (Ø x L) 30x100 mm	40101052
A 6-100 MIN. 6 PCS	B 100 G	for round bottomed tubes of 100 ml. Complete with glass tube of 100 ml. (Ø x L) 46x102 mm	40101092
	B 100 P	for round bottomed tubes of 100 ml. Complete with plastic tube of 100 ml. (Ø x L) 46x110 mm	40101102

HIGH SPEED ROTORS

FOR NEYA 16 AND NEYA 16 R

Name	Description	Max speed (rpm)	RCF max (xg)	n° of tubes max	p/n
A 6-50 HIGH SPEED	 34° fixed angle rotor for 50 ml tubes. With BIOSAFE lid It is supplied without buckets.	9500	10050	6	40100862
A 12-5	 45° fixed angle rotor for 5 ml Eppendorf® tubes With BIOSAFE lid	14000	20380	12	40100832
A 24-2	 45° Fixed angle rotor for 1,5-2 ml Eppendorf® tubes With BIOSAFE lid	15000	21000	24	40100842
A 36-05	 37° fixed angle rotor for 0,5 ml Eppendorf® tubes With BIOSAFE lid	15000	21.000	36	40100852
PCR 4-8	 45° fixed angle rotor for PCR strip of 8 tubes With BIOSAFE lid	15000	21000	4	40100872

Centrifuges

REDUCTORS - COMPLETE WITH BUCKETS - TUBES NOT INCLUDED

Name	Description	p/n
RE 15-5/7	Reductor for round bottomed tubes of 5/7 ml (Ø x L) 13x75 and 13x100 mm for rotor A32-15N	40101292
RE 50-15 F	Reductor for conical bottomed tubes type Falcon® of 15 ml. (Ø x L) 17x120 mm for rotor A 8-50 e A 6-50	40101322
RE 50-15 R	Reductor for round bottomed tubes of 15ml (Ø x L) 17x110 mm for rotor A 8-50 and A 6-50	40101332
RE 50-10	Reductor for round bottomed tubes of 10 ml (Ø x L) 16x100 mm for rotor A 8-50 and A 6-50	40101342
RE 100-50 F	Reductor for conical bottomed tubes of 50 ml type Falcon®. (Ø x L) 29x116 mm for rotor A 6-100	40101352
RE 100-50 R	Reductor for round bottomed tubes of 50 ml (Ø x L) 30x110 mm for rotor A 6-100	40101362
RE 100-15 F	Reductor for conical bottomed tubes of 15 ml type Falcon®. (Ø x L) 17x120 mm for rotor A 6-100	40101372
RE 100-15 R	Reductor for round bottomed tubes of 15 ml (Ø x L) 17x110 mm for rotor A 6-100	40101382

REDUCTORS - TUBES NOT INCLUDED

Name	Description	p/n
RE 2-05	Reductor for microtubes of 0,5 ml for rotor A 24-2. Kit of 24 pieces	40101262
RE 2-02	Reductor for microtubes of 0,2 ml for rotor A 24-2. Kit of 24 pieces.	40101272
RE 05-02	Reductor for microtubes 0,2 ml for rotor A 36-05. Kit of 36 pieces	40101282

R-5S +

- Maximum loading capacity 12X15 ml
- Max speed 5250 rpm
- Max RCF 4280xg
- Timer from 1 to 60 min or continuous

Ventilated benchtop centrifuge with LCD display to set the speed and time of centrifugation.

Low number of keys, adjustment handle with confirming function and guide for an extremely intuitive operativity.

Equipped with brushless motor, maintenance free and silent.

Programmable speed from 500 to 5250 rpm with step of 50 rpm.

Centrifugation time from 1 to 99 minutes with increases in 1 minute or constantly function.

Lower breaking time thanks to the function "BREAK"

Imbalance detection system with automatic functioning stop.

Automatic locking system of the lid with possibility to recover the tubes in case of electric power absence.

Compact sizes to optimize the space in laboratory.

The centrifuge follows the directives EN61010-1; EN61010-2-10

Power supply: 220V, 50 Hz.

Max. noisiness: 53 dB

Supplied with:

fixed angle aluminium rotor R-83A, 12x15 ml, steel buckets B 15-P and plastic round bottomed tubes T 15-P of 15 ml 17x100 mm.



R-83 A

Name	Load capacity	Max speed	External dimensions (L x W x H)	Weight	p/n
R-5S + CENTRIFUGE	12 X 15 ml	5250 rpm	33 x 37 x 28 cm	24 Kg	40000022

ACCESSORIES - FOR R-5S+

Name	Description	p/n
R-83 A ROTOR	Replacement rotor complete with tubes and buckets B 15-P	40000272
B 15-P CANISTER	Replacement metal bucket complete with plastic tube of 15 ml	40101022
B 15-F CANISTER	Spare part metal bucket complete with Falcon® tube of 15ml Max. 6 buckets to be placed into the internal spaces	40101002
RE 15-5/7	Reductor for round bottomed tubes of 5/7 ml (Ø x L) 13x75 and 13x100 mm for rotor R 83-A	40101292

MULTISPIN 12 ULTRACOMPACT

- Maximum loading capacity 6 X2 ml
- Max speed 12000 rpm
- Timer from 30 sec to 99 min

Ultra-compact minicentrifuge, equipped with silent induction motor and maintenance free; speed: adjustable from 1000 to 12,000 rpm with steps of 1000 in 1000 rpm.

Power supply: 220V, 50-60 Hz. Max. consumption: 30 W.

Max. noisiness: 45 dB.



Supplied with 2 rotors:

model A 6-2 able to hold simultaneously no. 6 tubes of 2 ml, no. 6 tubes of 0,5 ml, nr. 6 tubes of 0,2 ml;

model PCR 2-8 for no. 2 strips of 8 PCD tubes of 0,2 ml.

Name	Load capacity	Max speed	External dimensions (L x W x H)	Weight	p/n
MULTISPIN 12 MINICENTRIFUGE	6 x 2 ml	12000 rpm	122 x 176 x 196 mm.	1,5 Kg	40005012



Note

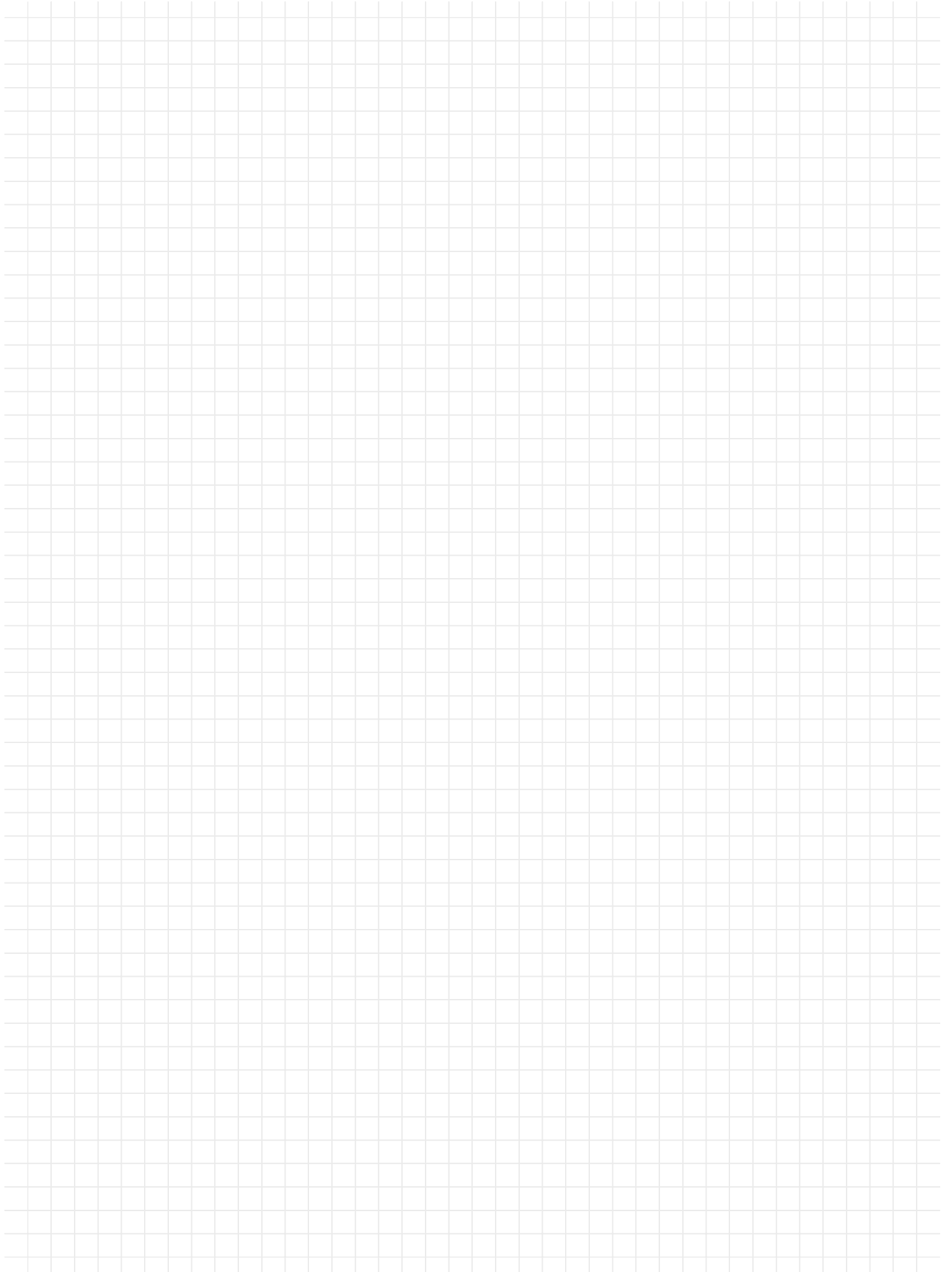

STIRRERS

ARGO LAB

WARRANTY
2
YEARS



★ ★ ★ ★ ★
EU ★ ★ ★ ★ ★
Designed

ISO 9001
CERTIFIED



All these instruments have passed the rigorous quality and reliability tests that Giorgio Bormac prepares on each new product.

The manufacturer, ISO 9001-certified and based in P.R.C., agreed to make the improvement changes we requested.

With this in mind, we decided to use our trademark: **ARGO LAB**.

Argo is the name of our dog, a black Labrador mix, whose strength and loyalty cheers our days at the office and at home..

That is why we want these tools to become faithful and reliable companions for your laboratory over time.

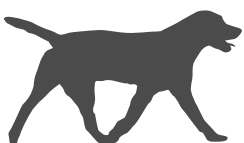

MS-D

Digital magnetic stirrer

LED display with continuous indication of the stirring speed.
Plate diam. 135 mm in Nylon + GF for excellent chemical resistance.
Maintenance-free induction motor. Degree of protection: IP 42.
Dimensions (LxWxH): 260x150x80mm.



Name	Volume	Speed	p/n
MS-D	3 L	200...1500 rpm	22002003

M2-A

Analogic magnetic stirrer with heating plate.

Stainless steel plate with diameter of 135 mm.
Induction motor without maintenance. Degree of protection: IP 42.
Dimensions (LxWxH): 280x160x65mm.



Name	Volume	Speed	T Max heating	Power heating	p/n
M2-A	20 L	0...1500 rpm	340 °C	500 W	22002013

M2-D Pro

Digital magnetic stirrer microprocessor with heating plate.

Multifunction LCD display with continuous indication of speed and temperature.
Control and maximum temperature protection with visual alarm on the display, "Stirring" function control. Stainless steel plate with diameter of 135 mm.
Input for external temperature probe PT 1000, RS 232 interface for remote control.
Induction motor without maintenance.
Degree of protection: IP 42. Dimensions (LxWxH): 280x160x65mm.



Name	Volume	Speed	T Max heating	Power heating	p/n
M2-D Pro	20 L	0...1500 rpm	340 °C	500 W	22002063

M3-D













Digital magnetic stirrer microprocessor with ceramic glass plate.

LED display with continuous indication of temperature.
Accuracy ± 1 °C with internal sensor, $\pm 0,2$ °C with external sensor.
Plate size 184 x 184 mm. Input for external temperature probe PT 1000.
Induction motor without maintenance. Degree of protection: IP 21.
Dimensions (LxWxH): 215x360x112mm.

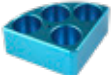

Name	Volume	Speed	T Max heating	Power heating	p/n
M3-D	10 L	0...1500 rpm	550 °C	1000 W	22003013

ACCESSORIES FOR MAGNETIC STIRRERS

Description		p/n
Adjustable support for PT 1000		22002523
PT 1000 probe, length 230 mm for stirrer M2-D Pro, M3-D		22002513
Reaction block for 100 ml round bottom flask		22002663
Reaction block for 250 ml round bottom flask		22002673
Reaction block for 500 ml round bottom flask		22002683
Black test tube block 4 holes 40ml Ø 28 mm		22002623
Blue test tube block 4 holes 30ml Ø 28 mm		22002613
Violet test tube block 4 holes 20ml Ø 28 mm		22002603
Gold test tube block 4 holes 16ml Ø 21,6 mm		22002643
Green test tube block 6 holes 8ml Ø 17,8 mm		22002633
Red test tube block 11 holes 4ml Ø 15,2 mm		22002593
Base for insertion of heating blocks		22002583
Plastic protective cover for stirrer M2-A, M2-D Pro		22002533



Example of using the test tube holder

AM 20-D

Mechanical shaft stirrer with LED display.
 Safe stop function with indicator light for overheating motor.
 Upper passage hole for stirring shafts.
 Supplied with automatic spindle (Ø shaft max 10 mm).
 Protection degree IP 42. Power supply 220V. Warranty: 24 months.

Supplied without universal reaction block (check part no. 22005153).



Name	Stirring Volume	Speed	Power	p/n
AM 20-D	20 L	50...2.200 rpm	50 W	22005013

AM 40-D Pro

Mechanical shaft stirrer with LCD display.
 Effort control with speed auto-adjustment.
 Torque trend display.
 Safe stop function with indicator light for overheating motor .
 Upper passage hole for stirring shafts.
 Supplied with automatic spindle (Ø shaft max 10 mm).
 Protection degree IP 21. Power supply 220V.

Supplied without universal reaction block (check part no. 22005153).



Name	Stirring Volume	Speed	Power	p/n
AM 40-D PRO	40 L	50...2.200 rpm	100 W	22005043

Universal stand



Becker holder



ACCESSORIES for AM 20-D and AM 40-D PRO

Description	L	Ø	Breadth	Material	p/n
TYPE 1: Stirring shaft with floating blade	400 mm	8 mm	90 mm	Stainless steel 316L	22005193
	350 mm	8 mm	89 mm	PTFE	22005333
TYPE 2: Stirring shaft with fixed blade.	400 mm	8 mm	60 mm	Stainless steel 316L	22005173
	350 mm	8 mm	70 mm	PTFE	22005313
TYPE 3: Stirring shaft with propeller blade.	400 mm	8 mm	50 mm	Stainless steel 316L	22005163
	350 mm	8 mm	65 mm	PTFE	22005303
TYPE 4: Stirring shaft with 3 holes blade.	400 mm	8 mm	68 mm	Stainless steel 316L	22005183
	350 mm	8 mm	68 mm	PTFE	22005323
TYPE 5: Anchor stirrer rod shaft.	600 mm	8 mm	100 mm	Stainless steel 316L	22005203
TYPE 6: Gear wheel stirrer, rod shaft.	600 mm	8 mm	100 mm	Stainless steel 316L	22005213
UNIVERSAL STAND. Complete with clamp Dimensions: base 200 x 315 mm, height 800 mm, diameter 18 mm					22005153
BECKER STAND with velcro strap and overgear chuck.					22005423
CLAMP					22005413



Type 1



Type 2



Type 3



Type 4



Type 5



Type 6

MIX

Mixer for test tubes, speed regulation from 0... 2,500 rpm.

Operation by touch or continuously.

Orbital shaking movement.

Eccentric motor with oil-free gears.

Degree of protection IP 21.

Dimensions (L x W x H): 127 x 160 x 130 mm. Weight: 3.5 kg.

220V power supply.



Name	Description	p/n
MIX	Vortex mixer	22008013

ACCESSORIES

Description	p/n
Universal support for Argolab MIX - REQUIRED TO INSTALL THE ADAPTERS	22008103
Adapter for 6 mm tubes - 48 places	22008113
Adapter for 10 mm tubes - 15 places	22008153
Adapter for 12 mm tubes - 16 places	22008123
Adapter for 16 mm tubes - 8 places	22008133
Standard top cup	22008143
Platform pad	22008163

SKO-D XL

Shaking stirrer.

Double LCD display with indication of speed and time.

Stirring time adjustment from 1min. ...20 hours or continuous.

Exit RS 232 for remote control.

Maintenance-free brushless DC motor.

Plate dimensions: 320 x 320mm.

Overall dimensions (L x W x H): 370 x 420 x 100 mm. Weight: 13,5 Kg.

Protection degree IP 21. Power supply 220V.

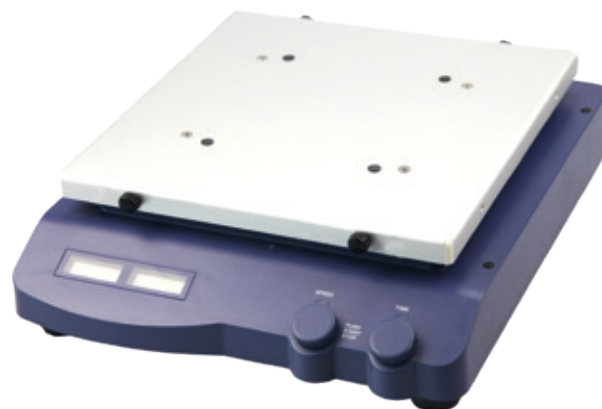

Supplied without any support.

Name	Movement	Max load	Speed	p/n
SKO-D XL ORBITAL	Orbital clockwise and counterwise	7,5 Kg	100...500 hit/min	22006013
SKO-D XL LINEAR	Linear amplitude 10 mm	7,5 Kg	100...350 hit/min	22006033
SKO-D XL 3D	3D clockwise and counterwise	5,0 Kg	10...70 hit/min	22006023

ACCESSORIES

Description	p/n
Support with anti-slip film	22006223
Universal support with 4 adjustable rollers	22006233
Additional bars for universal support	22006553
Drilled support for clips fixing	22006243
Fixing clip for flask volume 25 ml for fixing clip attachment. Max 28 clips	22006453
Fixing clip for flask volume 50 ml for fixing clip attachment. Max 16 clips	22006463
Fixing clip for flask volume 100 ml for fixing clip attachment. Max 16 clips	22006473
Fixing clip for flask volume 200/250 ml for fixing clip attachment. Max 9 clips	22006483
Fixing clip for flask volume 500 ml for fixing clip attachment. Max 9 clips	22006493



Dish attachment with non-slip mat

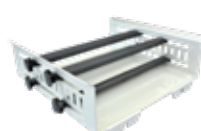

Universal attachment with 4 bars



Fixing clip attachment



SKI Shaking Incubators

Benchtop instrument that combines **stirring and thermostating** functions in a single instrument used to mix liquids and to incubate biological cultures.

The microprocessor control guarantees **constant and optimal control of the temperature inside the chamber**, the heating (and cooling in the SKI 8-R refrigerated model) pre-chamber, together with the forced air circulation, guarantee the **optimal temperature distribution throughout the useful work area**.

The **easy and intuitive digital display** allows the orbital shaking speed to be adjusted with an increase of 1 rpm (from 40 to 300 rpm), the temperature of use with sensitivity to the tenth of a degree (from + 5 ° C from room temperature up to + 60 ° C for model SKI 4 and from + 4 ° C up to + 60 ° C of the refrigerated model SKI 8-R) and the use time with sensitivity per minute (from 1 min up to 99 hours and 59 min or in a continuous cycle).

The gradually increasing stirring function up to the set speed ensures maximum sample safety.

The **various platforms available** allow the maximum versatility of the ArgoLab orbital shaking incubators in its SKI 4 and SKI 8-R models.

The SKI 4 and SKI 8-R instruments are supplied as standard with a flexible spring platform capable of housing different types of flasks, beakers and test tubes with different capacities; other platforms are also available: perforated for clips, with anti-slip film with rubber bands and universal with rollers.

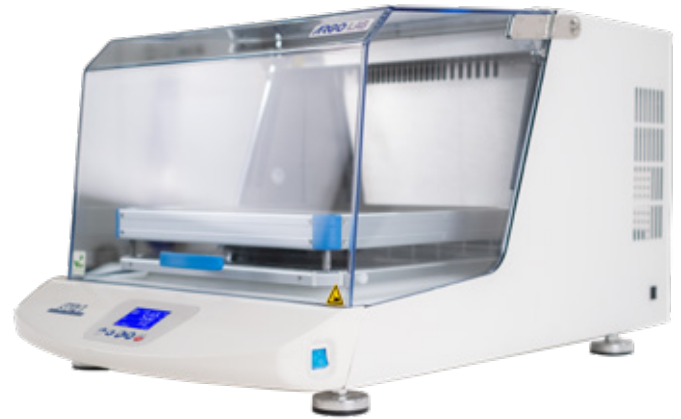

APPLICATIONS

- Bacterial cultures and yeasts ■
- Solubility studies ■
- Extraction procedures ■
- Mixing ■
- Colors and discolorations ■
- Hybridization ■
- Diagnostic tests ■
- Washing procedures ■
- Protein production ■
- Plasma production ■
- Biological shaker ■

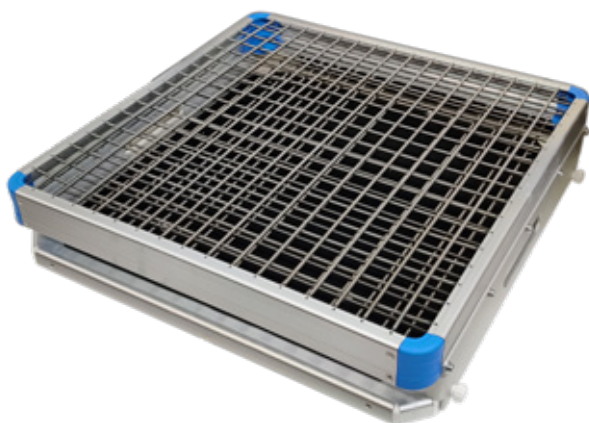

Universal platform with springs support



Keyboard

SKI 4

- **Stirring speed:** 40...300 rpm
- **Temperature range:** +5°C RT...60 °C
- **Stirring time:** 1...9999 min (or continuous)
- **Safety class 3.1 (DIN 12880)**

Shaking incubator with orbital rotating movement.

Backlit wide LCD display with simultaneous viewing of the real and set temperature and of the stirring speed and time.

Temperature range adjustable from 37 °C ± 0,1 °C, temperature uniformity in space at 37 °C ± 0,5 °C.

Maximum stirring width 20 mm.

The instrument can be used as "incubator" (stirring = 0) and "shaking" mode only (Incubation = ambient temperature).

Universal platform with springs support, useful dimensions 320 x 320 mm suitable for flasks, blocks, pipes and boxes with different dimensions.

Supplied as standard.

Possibility to place a drilled support for flasks/blocks clips holder.

A wide 8 mm thick plexiglass dome for optimum viewing of samples, without loss of heat, equipped with gas springs for easy opening.

Shaking and heating block system for dome opening with automatic restart after closing.

Safety systems for overheating protection and safety variable flow expansion thermostat.

Safety class 3.1 (DIN 12880).

Maintenance-free induction motor. Overall dimensions (L x W x H): 500 x 610 x 470) mm. Weight: 40 Kg. Power supply: 220V, nominal power 500 W.

Equipped with universal support, spring platform and hole for external temperature control.

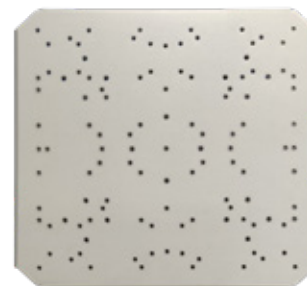
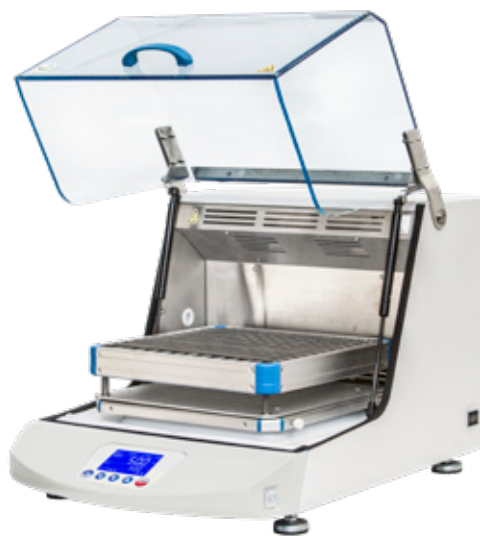

Holed support for clips

Name	Max capacity	Temperature range	Plate dimensions	p/n
SKI 4	4 L	+ 5 Ta... + 60 °C	320 x 320mm	41102012

ACCESSORIES

Description	p/n
Platform with no-slip mat	41102052
Universal platform with nr. 4 adjustable bars	41102042
Additional bar for universal platform	41102062
Holed platform for clips	41102112
Spring clips for 100 ml flasks for holed platform SKI 4. Max 23 clips	41102132
Spring clips for 200 / 250 ml flasks for holed platform SKI 4. Max 13 clips	41102142
Spring clips for 500 ml flasks for holed platform SKI 4. Max 8 clips	41102152
Spring clips for 1000 ml flasks for holed platform SKI 4. Max 4 clips	41102162
Spring clips for 2000 ml flasks for holed platform SKI 4. Max 1 clips	41102172

SKI 8 - SKI 8 R

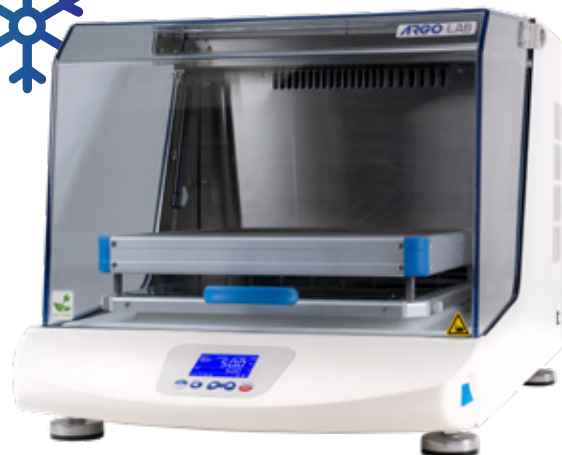

- **Stirring speed:** 40...300 rpm
- **Stirring time:** 1...99:59 min (or continuous)
- **Safety class** 3.1 (DIN 12880)
- **Plate dimension** 450 x 450 mm

Refrigerated biological incubator with orbital shaking, in ventilated (SKI 8) or refrigerated (SKI 8R) version.

Large backlit LCD display with simultaneous indication of set and actual temperature, stirring speed and time.

Temperature variation over time at 37 °C by ± 0.1 °C, temperature uniformity in space at 37 °C by ± 0.5 °C.

Maximum stirring width of 20 mm.

The instrument can independently manage agitation and temperature.

Universal platform with spring support useful dimensions 450 x 450 mm suitable for housing flasks, flasks, test tubes and containers of different sizes and shapes, supplied as standard.

Possibility to house perforated support for flask / flask holder clips.

Large 8 mm thick plexiglass dome for an optimal view of the samples without heat loss, equipped with gas springs to facilitate opening.

Shaking and heating blocking system for dome opening with automatic restart after closing.

Safety systems for overheating protection and safety thermostat. Safety class 3.1 (DIN 12880).

Maintenance free induction motor. Power supply 220V, nominal power 500 W.

Equipped with universal support, platform and hole for external temperature control.

Name	Max capacity	Temperature range	Power	Dimensions L x W x H (mm)	Weight Kg	p/n
NEW SKI 8	8 L	+ 5 Rt ... 60 °C	1000 W	610 x 840 x 540 mm	55	41102022
SKI 8 R COOLED	8 L	+ 4 ... + 60 °C	1.300 W	610 x 950 x 540 mm	95	41102032

ACCESSORIES

Description	p/n
Universal platform with nr. 4 adjustable bars for SKI 8 R	41102072
Support with anti-slip film (fixing bands included) for SKI 8 R	41102082
Holed support for fixing clips for SKI 8 R	41102122
Spring clips for 100 ml flasks for holed platform SKI 8 R. Max 36 clips	41102132
Spring clips for 200 / 250 ml flasks for holed platform SKI 8 R. Max 18 clips	41102142
Spring clips for 500 ml flasks for holed platform SKI 8 R. Max 16 clips	41102152
Spring clips for 1000 ml flasks for holed platform SKI 8 R. Max 9 clips	41102162
Spring clips for 2000 ml flasks for holed platform SKI 8 R. Max 4 clips	41102172

ARGO FILLER 3

Battery pipette filler, compatible with most of the plastic and glass pipettes from 1 to 100 ml, volumetric or graduated.

Exceptional aspiration and dispensing control thanks to compact and light design. Ergonomic design of the handle providing easy usability.

Eight different speeds of selection and large LCD display showing low battery warning.

The knurled handle, the ambidextrous design, the concave buttons and an easy control assure an easy and comfortable use of the operator's hands for many hours.

The fully autoclavable mouth includes a silicone adapter and a 0,45 µm hydrophobic membrane filter.

The kit includes the power supply for the rechargeable batteries and nr. 1 filter.



Name	Description	p/n
ARGO FILLER 3	Pipette filler	15100053
MEMBRANE FILTER SPARE PARTS	Membrane filters, hydrophobic 0,45µm. Kit of 10 pieces	15100573

OZ - OZONE GENERATORS

High power portable air / air Argolab ozonizers for home and professional use, equipped with multifunction digital timer, for daily/ weekly programs.

Ozone guarantee the natural inactivation of viruses, bacteria, mites, molds, spores, fungi, parasites and bad smells thanks to his hyper-oxidizing capacity.

Ozone react in a short time, returning O₂ without leaving traces of toxins.



Name	Ozone production	Operation Area	Weight	Dimensions (LxWxH)	p/n
OZ 10	10 g/h	150 m ³ /h	4 Kg	380 x 170 x 260 mm	41400103
OZ 30	30 g/h	230 m ³ /h	4 Kg	380 x 170 x 260 mm	41400203

THERMOSTATATION



SAFETY CLASS 3.1

(STANDARD DIN 12880)

Double over-temperature protection: in case of exceeding the set temperature, an electronic and an electromechanical control, both adjustable by the operator, intervene in succession. Even in the event of an unlikely total breakdown, the second protection is able to interrupt quickly the power of the heating element, being constituted by a fluid expansion switch and a temperature probe, which are totally independent from the electronics. All Argolab instruments have a degree of protection of Class 2 at least.

The ovens and other instruments with more powerful heating elements are in Safety Class 3.1.

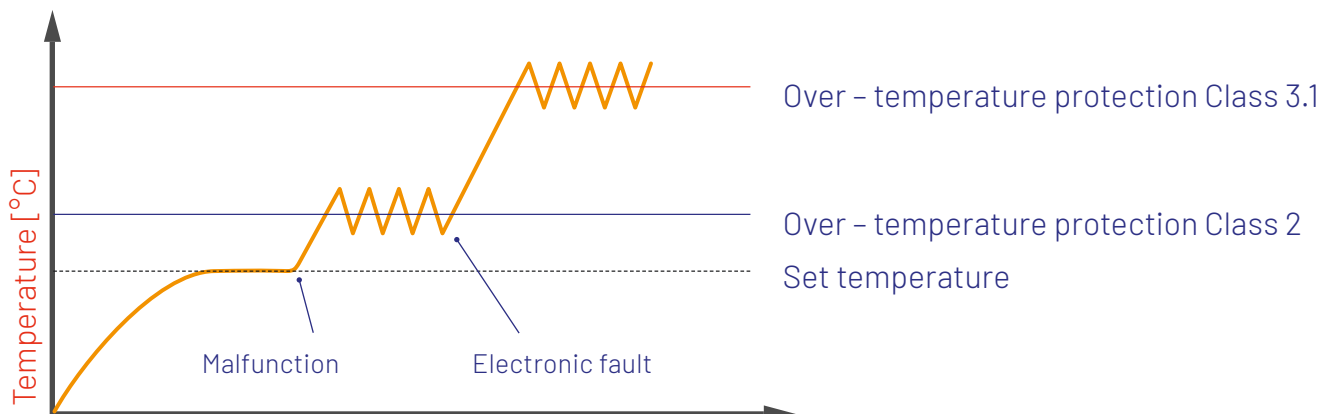

Super

PROJECT



All on board

Touch screen colour display for the selection of different functions. All parameters on a single screen: temperature, fan speed, time, program number and step, USB drive, date and time.



Easy to use

Easy and intuitive setting of all working parameters thanks to easy-to-understand icons and symbols. The capacitive display guarantees touch sensitivity and precision, even when wearing gloves.



Programs

Professional controller equipped with 8 storable programs with 8 steps each and an additional basic program (PROG 0) with a single step. Easy programming of all working steps in a single screen.



Safety of use

Setting menu with 3 access levels: no. 1 free and no. 2 protected by password in order to avoid accidental changes on the "sensitive" machine's parameters.



Recording and downloading data

The work cycles are automatically stored inside the instrument, always downloadable thanks to the USB port. With USB drive inserted, the recording takes place without capacity limits.

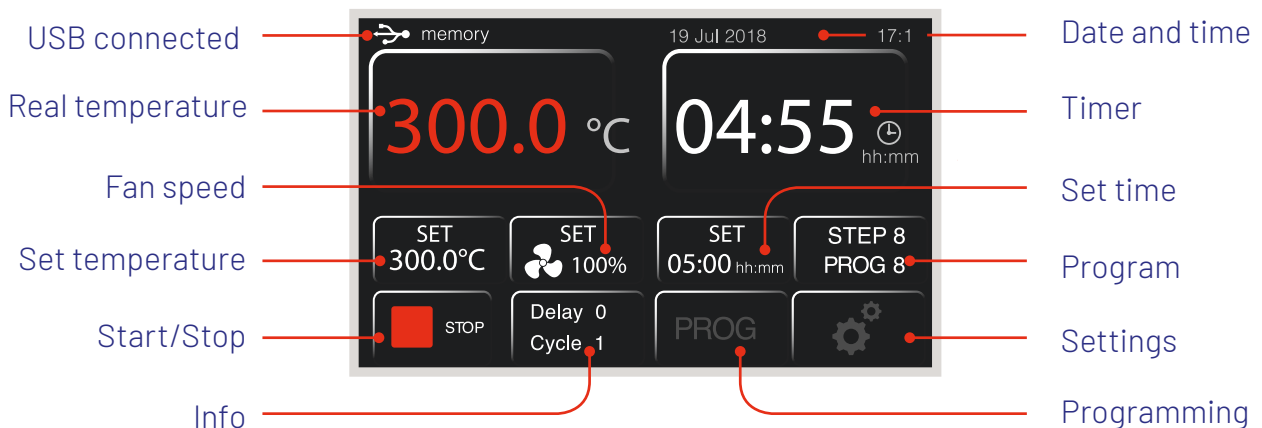

SERIE *Plus*



All in one

Backlit LCD display with all parameters in one screen: real temperature, set temperature, fan speed and running program



Intuitive reading

Easy reading of the most important parameters, thanks to the clear and logical distribution of numerical values, symbols and user-friendly icons.



Easy to use

The limited number of buttons and setting steps ensures an extremely intuitive and fast operability

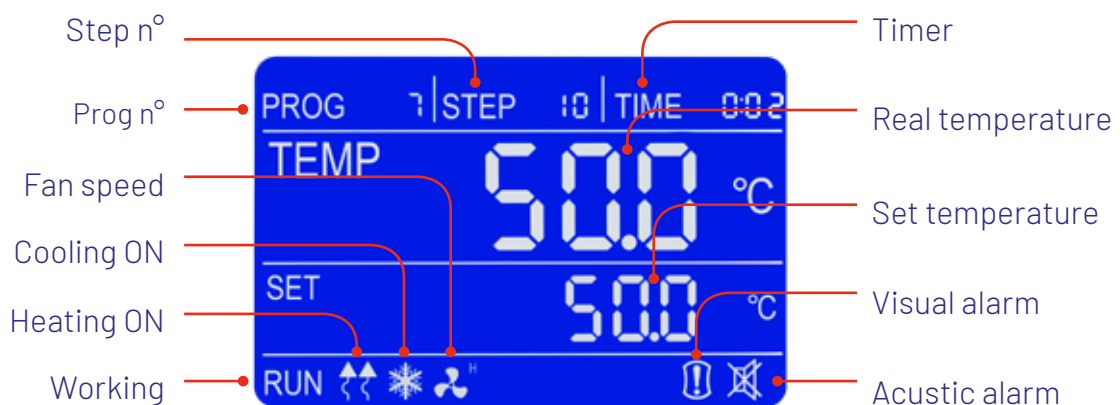

TCN SERIE *Super*

- Working range: +5 °C RT... +300 °C
- Coloured touchscreen display
- 8 storable programs with 8 steps each
- Basic program single step
- Data recording and downloading

Natural convection oven ArgoLab

Simultaneous display of all operating parameters. Visual and acoustic alarms which can be silenced by the operator. Digital timer with a range of programming 1 min - 99 h 59 min. and continuous working.

Possibility to set a delayed start of heating cycle.

"Safe temperature" function: working temperature limiter for sample protection.

Minimum heating times and reduced heating power for low energy consumption in every application.

Recording of working data without limit on USB drive.

Safety class 3.1(DIN 12880): maximum temperature regulator with fluid expansion.

Standard passage hole of Ø 5 mm (upper side) to insert an external temperature probe to control and/or certification of internal temperature.

Stainless steel chamber with rounded corners, supports and shelves completely removable for an



easy cleaning.

Power supply 220 ± 10% V - 50/60 Hz.

Supplied with: steel wire shelves (n° 2 shelves for models up to 50 l, n° 3 shelves for models over), calibration report at 150°C executed with certificated Accredia instrument, USB drive for recording and downloading data.

TCN SUPER

Name	Volume (l)	Stability at 150 °C	Homogeneity a 150 (°C)	External dim. LxWxH (mm)	Weight (kg)	Power (W)	p/n
TCN 50 SUPER	50	± 0,5	± 3,5	690 x 470 x 635	53	1000	41100502
TCN 115 SUPER	115	± 0,5	± 3,5	815 x 600 x 750	74	1900	41100512
TCN 200 SUPER	200	± 0,7	± 4,0	940 x 660 x 905	103	2100	41100522

TCN PLUS

Name	Volume (l)	Stability at 150 °C	Homogeneity a 150 (°C)	External dim. LxWxH (mm)	Weight (kg)	Power (W)	p/n
TCN 30* PLUS	30	± 0,5	± 3,5	460 x 530 x 685	40	700	41100062
TCN 50 PLUS	50	± 0,5	± 3,5	690 x 470 x 635	53	1000	41100002
TCN 115 PLUS	115	± 0,5	± 3,5	815 x 600 x 750	74	1900	41100012
TCN 200 PLUS	200	± 0,7	± 4,0	940 x 660 x 905	103	2100	41100022

* Working range TCN 30: +10°C T RT. ... +200 °C

TCN SERIE Plus

- Working range: +5°C RT ... +300 °C *
 - Backlit LED display
 - 7 storable programs with 10 steps each
 - Basic program *single* step
- * except TCN 30: +10°C T RT. ... +200 °C



Natural convection oven Argolab

Simultaneous display of all operating parameters. Visual and acoustic alarms which can be silenced by the operator. Digital timer with a range of programming 1 min - 99 h 59 min. and continuous working.

Possibility to set a delayed start of heating cycle.

"Safe temperature" function: working temperature limiter for sample protection.

Minimum heating times and reduced heating power for low energy consumption in every application.

Safety class 3.1(DIN 12880): maximum temperature regulator with fluid expansion.

Standard passage hole of Ø 5 mm (upper side) to insert an external temperature probe to control and/or certification of internal temperature.

Stainless steel chamber with rounded corners, supports and shelves completely removable for an easy cleaning.

Power supply 220 ± 10% V - 50/60 Hz.

Supplied with: steel wire shelves (n° 2 shelves for models up to 50 l, n° 3 shelves for models over), calibration report at 150°C executed with certificated Accredia instrument.

ACCESSORIES FOR TCN (SUPER AND PLUS)

Description		p/n
Steel wire shelves for TCN 30		41100142
Steel wire shelves for TCN 50		41100102
Steel wire shelves for TCN 115		41100112
Steel wire shelves for TCN 200		41100122
Holed platform for oven TCN 30		41100192
Holed platform for oven TCN 50		41100152
Holed platform for oven TCN 115		41100162
Holed platform for oven TCN 200		41100172
Internal hole Ø 25 mm complete with closing cap (Only on the sides shown in the picture - position to choose)		41110152
Internal hole Ø 50 mm complete with closing cap (Only on the sides shown in the picture - position to choose)		41110142
Wheels for TCN 200. Kit of 4 pieces		41101172
Manual IQ-00		41119002

TCF *SERIE Super*

- Working range: +10 °C RT ... +300 °C
- Coloured touchscreen display
- 8 storable programs with 8 steps each
- Basic program single step
- Data recording and downloading

Forced air oven ArgoLab

Simultaneous display of all operating parameters. Visual and acoustic alarms which can be silenced by the operator.

Digital timer with a range of programming 1 min - 99 h 59 min. and continuous working.

Possibility to set a delayed start of heating cycle.

"Safe temperature" function: working temperature limiter for sample protection.

Adjustable fan on 3 levels: High= 100% - Medium = 75% - Low= 50%
Minimum heating times and reduced heating power for low energy consumption in every application.

Recording of working data without limit on USB drive.

Safety class 3.1 (DIN 12880): maximum temperature regulator with fluid expansion.

Standard passage hole of Ø 5 mm (upper side) to insert an external temperature probe to control and/or certification of internal



temperature.

Stainless steel chamber with rounded corners, supports and shelves completely removable for an easy cleaning.

Power supply 220 ± 10% V - 50/60 Hz.

Supplied with: steel wire shelves (n°2 shelves for models up to 50 l, n°3 shelves for models over), calibration report at 150°C executed with certificated Accredia instrument, USB drive for recording and downloading data.

TCF SUPER

Name	Volume (l)	Stability at 150 °C	Homogeneity a 150 (°C)	External dim. LxWxH (mm)	Weight (kg)	Power (W)	p/n
TCF 50 SUPER	50	± 0,3	± 2%	690 x 570 x 635	54	980	41100602
TCF 120 SUPER	120	± 0,3	± 2%	810 x 690 x 750	74	1900	41100612
TCF 200 SUPER	200	± 0,4	± 2%	945 x 755 x 870	103	2400	41100622
TCF 400 SUPER	400	± 0,5	± 2%	1285 x 870 x 1060	160	3200	41100632

TCF PLUS

Name	Volume (l)	Stability at 150 °C	Homogeneity a 150 (°C)	External dim. LxWxH (mm)	Weight (kg)	Power (W)	p/n
TCF 50 PLUS	50	± 0,3	± 2%	690 x 570 x 635	54	980	41100202
TCF 120 PLUS	120	± 0,3	± 2%	810 x 690 x 750	74	1900	41100212
TCF 200 PLUS	200	± 0,4	± 2%	945 x 755 x 870	103	2400	41100222
TCF 400 PLUS	400	± 0,2	± 2%	1285 x 870 x 1060	160	3200	41100232

TCF SERIE Plus

- Working range: +10 °C RT ... +300 °C
- Backlit LED display
- 7 storable programs with 10 steps each
- Basic program *single* step



Forced air oven ArgoLab

Simultaneous display of all operating parameters. Visual and acoustic alarms which can be silenced by the operator.

Digital timer with a range of programming 1 min - 99 h 59 min. and continuous working.

Possibility to set a delayed start of heating cycle.

"Safe temperature" function: working temperature limiter for sample protection.

Adjustable fan on 3 levels: High= 100% - Medium = 75% - Low= 50%

Minimum heating times and reduced heating power for low energy consumption in every application.

Safety class 3.1 (DIN 12880): maximum temperature regulator with fluid expansion.



Standard passage hole of Ø 5 mm (upper side) to insert an external temperature probe to control and/or certification of internal temperature.

Stainless steel chamber with rounded corners, supports and shelves completely removable for an easy cleaning.

Power supply 220 ± 10% V - 50/60 Hz.

Supplied with: steel wire shelves (n°2 shelves for models up to 50 l, n°3 shelves for models over), calibration report at 150°C executed with certificated Accredia instrument.

ACCESSORIES TCF (SUPER AND PLUS)

Description		p/n
Steel wire shelves for TCF 50		41100102
Steel wire shelves for TCF 120		41100112
Steel wire shelves for TCF 200		41100122
Steel wire shelves for TCF 400		41100132
Holed platform for oven TCF 50		41100152
Holed platform for oven TCF 120		41100162
Holed platform for oven TCF 200		41100172
Holed platform for oven TCF 400		41100182
Internal hole Ø 25 mm complete with closing cap (Only on the sides shown in the picture - position to choose)		41110152
Internal hole Ø 50 mm complete with closing cap (Only on the sides shown in the picture - position to choose)		41110142
Wheels for TCF 200 and 400. Kit of 4 pieces		41101172
Manual IQ-00		41119002

Thermostating

ICN *SERIE Super*

- Working range: +5 °C RT ... +70 °C
- Coloured touchscreen display
- 8 storable programs with 8 steps each
- Basic program single step
- Data recording and downloading

Natural convection oven ArgoLab

Simultaneous display of all operating parameters. Visual and acoustic alarms which can be silenced by the operator.

Digital timer with a range of programming 1 min - 99 h 59 min. and continuous working.

Possibility to set a delayed start of heating cycle.

"Safe temperature" function: working temperature limiter for sample protection.

Minimum heating times and reduced heating power for low energy consumption in every application.

Recording of working data without limit on USB drive.

Safety class 2 (DIN 12880)

Samples checking without heat loss: wide glass window door (ICN 16 and ICN 35), double door (the internal one is made of glass) for the other models.

Standard passage hole of Ø 5,5 mm (upper side) to insert an external temperature probe to control and/or certification of in-



ternal temperature.

Stainless steel chamber with rounded corners, supports and shelves completely removable for an easy cleaning.

Power supply 220 ± 10% V - 50/60 Hz.

Supplied with: steel wire shelves (n°2 shelves for models up to 55 l, n°3 shelves for models over), calibration report at 37 °C executed with certificated Accredia instrument, USB drive for recording and downloading data.

ICN SUPER

Name	Volume (l)	Stability at 150 °C	Homogeneity a 150 (°C)	External dim. LxWxH (mm)	Weight (kg)	Power (W)	p/n
ICN 16 SUPER	16	± 0,3	± 0,4	530 x 400 x 370	23	85	41101302
ICN 35 SUPER	35	± 0,3	± 0,4	620 x 460 x 440	33	125	41101312
ICN 55 SUPER	55	± 0,3	± 0,5	660 x 545 x 500	42	250	41101322
ICN 120 SUPER	120	± 0,3	± 0,5	780 x 645 x 610	61	350	41101332
ICN 200 SUPER	200	± 0,3	± 0,5	875 x 710 x 755	77	600	41101342

ICN PLUS

Name	Volume (l)	Stability at 150 °C	Homogeneity a 150 (°C)	External dim. LxWxH (mm)	Weight (kg)	Power (W)	p/n
ICN 16 PLUS	16	± 0,3	± 0,4	530 x 400 x 370	23	85	41101002
ICN 35 PLUS	35	± 0,3	± 0,4	620 x 460 x 440	33	125	41101012
ICN 55 PLUS	55	± 0,3	± 0,5	660 x 545 x 500	42	250	41101022
ICN 120 PLUS	120	± 0,3	± 0,5	780 x 645 x 610	61	350	41101032
ICN 200 PLUS	200	± 0,3	± 0,5	875 x 710 x 755	77	600	41101042

ICN SERIE Plus

- Working range: +5 °C RT... +70 °C
- Backlit LED display
- 7 storable programs with 10 steps each
- Basic program *single* step

Natural convection oven Argolab

Simultaneous display of all operating parameters. Visual and acoustic alarms which can be silenced by the operator.

Digital timer with a range of programming 1 min - 99 h 59 min. and continuous working.

Possibility to set a delayed start of heating cycle.

“Safe temperature” function: working temperature limiter for sample protection.

Minimum heating times and reduced heating power for low energy consumption in every application.

Safety class 2 (DIN 12880)

Samples checking without heat loss: wide glass window door (ICN 16 and ICN 35), double door (the internal one is made of glass) for the other models.

Standard passage hole of Ø 5,5 mm (upper side) to insert an external temperature probe to control and/or certification of internal temperature.

Stainless steel chamber with rounded corners, supports and shelves completely removable for an easy cleaning.

Power supply 220 ± 10% V - 50/60 Hz.

Supplied with: steel wire shelves (n°2 shelves for models up to 55 l, n°3 shelves for models over), calibration report at 37°C executed with certified Accredia instrument.



Internal glass door

Thermostating

ACCESSORIES FOR ICN (SUPER AND PLUS)

Description	p/n
Steel wire shelves for ICN 16	41101112
Steel wire shelves for ICN 35	41101122
Steel wire shelves for ICN 55	41101132
Steel wire shelves for ICN 120	41101142
Steel wire shelves for ICN 200	41101152
Wheels for ICN 200. Kit of 4 pieces	41101172
Manual IQ-00	41119002



ICF *SERIE Super*

- Working range: +5 °C RT ... +80 °C
- Coloured touchscreen display
- 8 storable programs with 8 steps each
- Basic program single step
- Data recording and downloading
- Sterilization program at 130 °C

Forced air incubator ArgoLab

Simultaneous display of all operating parameters. Visual and acoustic alarms which can be silenced by the operator. Digital timer with a range of programming 1 min - 99 h 59 min. and continuous working.

Possibility to set a delayed start of heating cycle.

"Safe temperature" function: working temperature limiter for sample protection.

Special program for **sterilization** at 130 °C.

Adjustable fan on 3 levels: High= 100% - Medium = 75% - Low= 50%

Minimum heating times and reduced heating power for low energy consumption in every application.

Recording of working data without limit on USB drive.

Safety class 3.1 (DIN 12880): maximum temperature regulator with fluid expansion.

Standard passage hole of Ø 5 mm (upper side) to insert an



external temperature probe to control and/or certification of internal temperature.

Stainless steel chamber with rounded corners, supports and shelves completely removable for an easy cleaning.

Power supply 220 ± 10% V - 50/60 Hz.

Supplied with: 3 steel wire shelves, calibration report at 37 °C executed with certificated Accredia instrument, USB drive for recording and downloading data. (ICF 55 2 steel wire shelves).

ICF SUPER

Name	Volume (l)	Stability at 150 °C	Homogeneity a 150 (°C)	External dim. LxWxH (mm)	Weight (kg)	Power (W)	p/n
NEW ICF 55 SUPER	57	± 0,1	± 0,3	690 x 650 x 620	56	350	41100902
ICF 120 SUPER	120	± 0,1	± 0,4	810 x 690 x 750	74	600	41100912
ICF 200 SUPER	200	± 0,2	± 0,4	945 x 755 x 870	103	700	41100922
ICF 400 SUPER	400	± 0,3	± 0,5	1285 x 750 x 1060	160	1500	41100932

ICF PLUS

Name	Volume (l)	Stability at 150 °C	Homogeneity a 150 (°C)	External dim. LxWxH (mm)	Weight (kg)	Power (W)	p/n
NEW ICF 55 PLUS	57	± 0,1	± 0,3	690 x 650 x 620	56	350	41100802
ICF 120 PLUS	120	± 0,1	± 0,4	810 x 690 x 750	74	600	41100812
ICF 200 PLUS	200	± 0,2	± 0,4	945 x 755 x 870	103	700	41100822
ICF 400 PLUS	400	± 0,3	± 0,5	1285 x 750 x 1060	160	1500	41100832

ICF SERIE Plus

- Working range: +5 °C RT ... +80 °C
- Backlit LED display
- 7 storable programs with 10 steps each
- Basic program *single* step
- Sterilization program at 130 °C

Forced air incubator ArgoLab

Simultaneous display of all operating parameters. Visual and acoustic alarms which can be silenced by the operator. Digital timer with a range of programming 1 min - 99 h 59 min. and continuous working.

Possibility to set a delayed start of heating cycle.

“Safe temperature” function: working temperature limiter for sample protection.

Special program for **sterilization** at 130° C.

Adjustable fan on 3 levels: High= 100% - Medium = 75% - Low= 50%

Minimum heating times and reduced heating power for low energy consumption in every application.

Safety class 3.1 (DIN 12880): maximum temperature regulator with fluid expansion.



Standard passage hole of Ø 5 mm (upper side) to insert an external temperature probe to control and/or certification of internal temperature.



Stainless steel chamber with rounded corners, supports and shelves completely removable for an easy cleaning.

Power supply 220 ± 10% V - 50/60 Hz.

Supplied with: 3 steel wire shelves, calibration report at 37 °C executed with certificated Accredia instrument. (ICF 55 2 steel wire shelves).

Description		p/n
Steel wire shelves for ICF 55		41100102
Steel wire shelves for ICF 120		41100112
Steel wire shelves for ICF 200		41100122
Steel wire shelves for ICF 400		41100132
Holed platform for ICF 55		41100152
Holed platform for ICF 120		41100162
Holed platform for ICF 200		41100172
Holed platform for ICF 400		41100182
Internal hole Ø 25 mm complete with closing cap (Only on the sides shown in the picture - position to choose)		
Internal hole Ø 50 mm complete with closing cap (Only on the sides shown in the picture - position to choose)	41110142	
Wheels for ICF 200 and ICF 400. Kit of 4 pieces		41101172
Manual IQ-00		41119002

Thermostating

IC 150-R

- Working range: 0 ... +60 °C
- Volume 150 l
- Backlit LCD display
- 7 storable programs with 10 steps each
- Basic program *single* step

Air forced cooled incubator Argolab.

Simultaneous display of all operating parameters.

Backlit LCD display, 7 storable programs with 10 steps each (temperature, time, fan speed) and one additional basic simple-step program (temperature, time, fan speed).

Visual and acoustic alarms which can be silenced by the operator.

Digital timer with a range of programming 1 min - 99 h 59 min. and continuous working.

Possibility to set a delayed start of heating cycle.

"Safe temperature" function: working temperature limiter for sample protection.

Safety class 3.1 (DIN 12880): maximum temperature regulator with fluid expansion.

Lateral internal passage hole of Ø 25 mm to insert one or more external temperature probes to control and/or certification of internal temperature. Stainless steel chamber with rounded corners, supports and shelves completely removable for an easy cleaning.

Power supply 220 ± 10% V - 50 Hz.

Supplied with: three steel wire shelves, calibration report at 25°C executed with certificated Accredia instrument.



Name	Volume (l)	Stability at 150 °C	Homogeneity at 150 (°C)	External dim. LxWxH (mm)	Weight (kg)	Power (W)	p/n
IC 150-R PLUS	150	± 0,1	± 0,5	650 x 620 x 1350	100	1100	41101512

ACCESSORIES IC 150-R

Description	p/n
Steel wire shelves for IC 150-R	41101562
Internal hole Ø 25 mm complete with closing cap (On upper and lateral sides only)	41110152
Internal hole Ø 50 mm complete with closing cap (On upper and lateral sides only)	41110142
Manual IQ-00	41119002

CH 150 / CH 250 CLIMATIC CHAMBERS

- Working range RH: +55... +95 % RH
- Working range with humidity: +10 ... 70 °C
- Working range without humidity: 0 ... +85 °C
- Customisable programs from 1 to 100 steps

Climatic chamber ArgoLab.

Backlit alphanumeric LCD digital display.

Digital timer, clock with hour and date for GLP functions.

Standard supplied mini printer for operating and set parameters output.

Safety class 3.1(DIN 12880): maximum temperature regulator with fluid expansion.

Stainless steel chamber with rounded corners.

External steel door with wide glass window and inner led lamp for observation of the samples.

Side hole of Ø 25 mm to insert one or more external temperature probes to control and/or certification of internal temperature.

Power supply 220 ± 10% V - 50 Hz.

Temperature homogeneity in the chamber:

±0,5 °C (without humidity), ± 1,5 °C (10 °C ÷ 70 °C / 55 ÷ 95% RH)

Temperature variation over time:

±0,2 °C (without humidity), ± 0,5 °C (10 °C ÷ 70 °C / 55 ÷ 95% RH)

Humidity fluctuation:

≤ 2 % (10 °C ÷ 70 °C / 55 ÷ 95% RH)

Supplied with: three steel wire shelves, water tank for humidity generator.

The climatic chambers are delivered after being carefully tested.



T-H working range

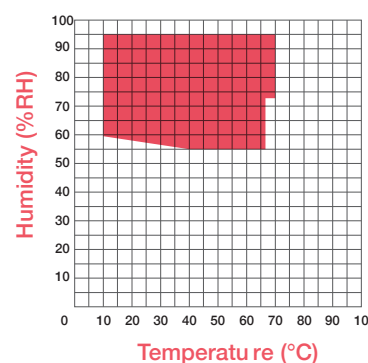

Name	Volume (l)	External dimensions LxWxH (mm)	Weight (kg)	p/n
CH 150	150	690 x 790 x 1520	145	41101412
CH 250	250	740 x 885 x 1680	185	41101422

ACCESSORIES CH 150 / CH 250

Description	p/n
Steel wire shelves for CH 150	41101462
Steel wire shelves for CH 250	41101472
Manual IQ-00	41119002
Ordinary maintenance service	41119019
Ordinary maintenance and/or calibration and/or mapping service	41119029

CB 5 SERIES CIRCULATING WATERBATH

- Working range: -30 / -20 / -10 ... +100 °C
- Volume: 5 l
- Probe PT100 to control the temperature of the external cycle
- Backlit LED display

Circulating waterbath Argolab.

Simultaneous display of set temperature, both real and of all the other operating parameters. Visual and acoustic alarms which can be silenced by the operator.

Digital timer with a range of programming 1 min - 99 h 59 min. and continuous working.

Possibility to set a delayed start of heating cycle.

"Safe temperature" function: working temperature limiter for sample protection.

Safety class 3 (DIN 12880)

Simultaneous circulation of the fluid inside and outside the tank to improve the thermic stability and inertia.

Automatic reading of the temperature of the external cycle through the probe PT100 supplied as standard.

Handy pipe to exclude the external circulation for an easy cleaning and maintenance.

Safety system in case of absence of the thermal fluid.

Internal stainless-steel tank, equipped with lid, easily accessible.

Power supply: 220 ± 10% V - 50 Hz.



Supplied with: probe PT100 for the external control of the temperature.

Set of two 2 mt. pipes with insulating material (working range -40...+60 °C), metal clamps, and pipe fittings.

MODELS

Name	Volume (l)	Working range (°C)	Dimensions LxWxH (mm)	Weight (kg)	Power (W)	p/n
CB 5-10	5	-10 ... +100	290 x 570 x 710	34	2300	41102202
CB 5-20	5	-20 ... +100	380 x 670 x 840	54	2600	41102212
CB 5-30	5	-30 ... +100	380 x 670 x 840	54	2600	41102222

ACCESSORIES FOR CB

	Description	p/n
PIPES	Kit of two 2 mt. pipes with insulating material (working range -40...+60 °C), complete with metal clamps for fastening to the pipe fittings.	41102302
WHEELS	Kit of 4 swivel wheels, two of which can be braked	41102312
THERMAL FLUID	Pre-mixed ready-to-use thermal fluid, working range -30...+80 °C. 5 litres tank.	41102322
PT 56 TFE	External temperature probe in TFE for CB	51000252

WB SERIES

- Working range : +5°C RT ... +85 / +100 °C
- Volume 5 / 12 / 22 / 40 l
- Backlit LED display



Waterbath Argolab.

Safety class 2 (DIN 12880).

Visual and acoustic alarms which can be silenced by the operator.

Digital timer with a range of programming 1 min - 99 h 59 min. and continuous working.

Possibility to set a delayed start of heating cycle.

“Safe temperature” function: working temperature limiter for sample protection.

Internal tank and drilled bottom plate (removable) in high quality

stainless steel.

WB 22 Pump and WB 40 Pump ensure a faster and more uniform temperature distribution thanks to the recirculation pump.

Power supply: 220 ± 10% V - 50/60 Hz.

Supplied with: stainless steel lid with 5 mm hole for the passage of an external probe, drilled bottom plate and a pipe for the drainage of the tank and quick-acting valve for periodic fluid replacement.

Name	Volume (l)	Working range (°C)	Stability at 37°C	Tank dimensions LxWxH (mm)	Disposition rack	p/n
WB 5	5	+5 Ta ... +100* <i>* 100 °C reachable with thermal fluid</i>	± 0,1	300 x 155 x 150		41101592
WB 12	12	+5 Ta ... +100* <i>* 100 °C reachable with thermal fluid</i>	± 0,1	300 x 240 x 200		41101602
WB 22	22	+5 Ta ... +100* <i>* 100 °C reachable with thermal fluid</i>	± 0,1	500 x 295 x 200		41101712
WB 22 PUMP	22	+5 Ta ... +85	± 0,1	500 x 295 x 200		41101612
WB 40 PUMP	40	+5 Ta ... +85	± 0,2	645 x 395 x 200		41101622

ACCESSORIES FOR WB

	Modules	p/n
RACK 1 for pipes Ø13mm / 20 places	1	41101802
RACK 2 for pipes Ø18mm / 20 places	1	41101812
RACK 3 for pipes Ø31mm / 5 places	1	41101822
RACK 4 for pipes Ø56mm / 8 places (biberon)	3	41101842
RACK 5 for blood sachets / 5 places	3	41101852
BECKER SUPPORT FOR WB 12 / 4 places		41101952
BECKER SUPPORT FOR WB 22 / 8 places		41101962
NEW SIDE HANDLE for WB 5 and WB 12		41101872

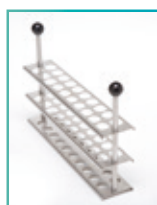

RACK 1
Ø13mm

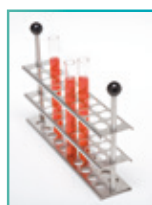

RACK 2
Ø18mm



RACK 3
Ø31mm

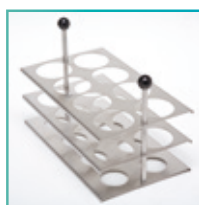

RACK 4
Ø56mm



RACK 5
for blood sachets



BECKER SUPPORT

Thermostating

SB 35 SHAKING BATH

- Working range : $+5^{\circ}\text{C RT} \dots +100^{\circ}\text{C}$
- Tank capacity: 35 litres
- Backlit LED display



Horizontal shaking bath (Dubnoff) Argolab.
 Visual and audible alarms that can be silenced by the operator.
 Digital timer with programming range 1 min - 99 h 59 min and continuous operation.
 Delayed start function of heating cycle.
 "Safe temperature" function: working temperature limitation for sample protection.
 Safety class 2 (DIN 12880).

Power supply: 230V/50Hz, weight : 28kg.

Supplied with: stainless steel lid with 5 mm hole to insert an external probe, universal basket with stainless steel spring supports, a pipe for the drainage of the tank and quick-acting valve for periodic fluid replacement.

MODEL

Name	Volume (l)	Working range ($^{\circ}\text{C}$)	Stability at 37°C	Homogeneity at 37°C	Basket dimensions LxWxH (mm)	p/n
SB 35	35	+5 Ta ... +100	$\pm 0,5$	± 1	320 x 200 x 115	41101732



NEW DRY BATH

- Working range : +25 ... +120 °C
- Accurate and uniform temperature control
- Backlit LED display
- 1 point calibration



ArgoLab dry bath with 1-point calibration function.
 Settable temperature range between +25 and +120°C.
 Calibration on 1 point by a simple operation.
 Accurate and uniform temperature control ($\pm 0.5^\circ\text{C}$ @ 37°C).
 "Hot" function for user safety Overheating function (140°C).
 Several types of hostable blocks compatible with most common \varnothing cuvettes (9 types).
 LED display with "real time" temperature display and remaining heating time.
 Supplied as standard with lid for better heat preservation and safety.

The Argolab HB 120-C dry bath can accommodate up to 10 different test tube blocks, differing in number and volume.
 Each block has a central thread for extraction (via dedicated rod) and at least 2 holes for temperature control (hole \varnothing 3 mm).
 Each block is supplied without an extraction rod.

Supplied with

- Power cable
- Plastic cover
- Extracting rod heating block
- BLOCK NOT INCLUDED**















Thermostating

Name	Working range (°C)	Accuracy a 37 (°C)	p/n
NEW HB 120-C	+25 ... +120	$\pm 0,5$	22010013

NEW HEATING BLOCKS

The Argolab HB 120-C dry bath can accommodate up to 10 different test tube blocks, differing in number and volume. Each block has a central thread for extraction (via dedicated rod) and at least 2 holes for temperature control (hole Ø 3 mm). Blocks are supplied without the extraction rod.

Name	Description	p/n
Microplates		22010203
8 places x 50 ml		22010193
28 places x 5/15 ml		22010173
45 places x 5 ml		22010183
40 places x 0,5 ml		22010133
40 places x 1,5 ml		22010143
40 places x 2,0 ml		22010153
54 places x 0,2 ml		22010123
18 places x 0,2 / 0,5 / 1,5 / 2 [ml]		22010163
BATHTUB + SPHERES KIT		22010103
BATHTUB		22010113
ALUMINUM SPHERES 1 KG		22010213

NEW DU - DIGITAL ULTRASONIC BATHS

- Working range: +5°C Ta ... +60 °C
- Backlit LED display
- Ultrasonic frequency 40/28 KHz.
- Timer from 1 to 99 minutes.
- Sweep, Pulse and Degas functions



Argolab digital ultrasonic bath with integrated Sweep technology and equipped with Pulse and Degas functions.

Digital illuminated displays showing current and set temperature, timer, ultrasonic power level and operating frequency.

Separate control of ultrasound, heating and Pulse and Degas functions.

Temperature control up to 60°C.

Timer can be set from 1 to 99 minutes.

On models DU-100S / DU-220S / DU-450S there is a tap for emptying the tank.

Supplied as standard: stainless steel basket and lid.



MODEL

Name	Volume (l)	Heating power (W)	Ultrasonic power (W)	Tank dimensions LxWxH (mm)	Weight (kg)	p/n
DU-06	0,6	Not heating	50	150 x 85 x65	1,35	41300323
NEW DU-32S	3,2	100	120	240 x 135 x100	3,80	41300333
NEW DU-45S	4,5	200	180	300 x 150 x 100	4,40	41300343
NEW DU-65S	6,5	200	180	300 x 150 x150	5,40	41300353
NEW DU-100S	10	500	240	300 x 240 x150	8,20	41300363
NEW DU-220S	22	500	480	500 x 300 x 150	13,20	41300373
NEW DU-450S	45	1000	720	500 x 300 x 300	17	41300383

CE-5700

No-heating digital ultrasonic bath with volume: 0,75L.

Particularly recommended for jewellers.

Digital display, touch screen panel,

Adjustable timer 90-180-280-380-480 Sec.

Ultrasonic frequency 42 KHz.

Supplied with: basket and lid.



Name	Volume (l)	Ultrasonic power (W)	Tank dimensions LxWxH (mm)	Weight (Kg)	p/n
CE-5700	0,75	50	150 x 130 x 50	0,97	41300303

Thermostating

AU - ANALOGIC ULTRASONIC BATHS

- Working range : +5°C RT ... +80 °C
- Ultrasonic frequency: 40 KHz.
- Timer from 1 to 30 minutes, or in continuous..

Analogic ultrasonic bath.
Temperature adjustment up to 80°C .
Adjustable timer from 1 to 30 minutes and limitless.
Ultrasonic frequency 40 KHz.

Supplied with: basket and stainless steel lid.

On AU 220 and AU 450 models, there is a tap for emptying the tank.



MODELS

Name	Volume (l)	Heating power (W)	Ultrasonic power (W)	Tank dimensions LxWxH (mm)	Weight (kg)	p/n
AU-32	3,2	100	120	240 x 135 x 100	3,80	41300403
AU-65	6,5	200	180	300 x 150 x 150	5,40	41300413
AU-220	22	500	480	500 x 300 x 150	13,20	41300433
AU-450	45	1000	750	500 x 300 x 300	17,00	41300423

ACCESSORIES

Name	Description	p/n
CLEANER	Universal cleaning solution. Bottle of 30 ml	41300253
CLEANER	Universal cleaning solution. Bottle of 500 ml	41300263
BECKER SUPPORT	For DU-45 DU-65 e AU-65, with 2 holes	41300513
BECKER SUPPORT	For DU-100, with 4 holes	41300533
SS-200 SIEVE HOLDER	Sieve holder. Compatible with AU-450 model only. Holder for no. 5 sieves of 80 mm or no. 6 sieves of 60 mm thick.	41300203

ARGO FREDDO

ARGO LAB

WARRANTY
3
YEARS



EU Designed



RESOLUTION 0,1°C



MIN-MAX ALARM

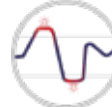

HOMOGENEITY
EN 60068-3



VENTILATION
(FR series)



DEFROST



OPEN DOOR
ALARM



KEY LOCK



PLASTIFIED STEEL
SHELVES



REMOTE ALARM
CONTACT



LED
LIGHTS



REVERSIBLE
DOOR



ECO FRIENDLY
GAS



THROUGH-HOLE
10 mm



WHEELS
(260 L)



CALIBRATION
REPORT



FR REFRIGERATORS

- Temperature range: +2 ... +8 °C
- Internal volume: 110 - 260 L
- LED display

Professional laboratory refrigerators, with digital display and electronic control, temperature alarms, door sensor and manual/automatic defrost.

Smart refrigerated instruments, the internal parameters can be adjusted according to even the most restrictive needs.

The highly efficient compressors contain "environment friendly" ecological gases, free of CFCs and HCFCs, in compliance with the directive 2014/68 / EU.

The internal dynamic ventilation system guarantees the best conditions for the storage of even the most sensitive materials, in compliance with the EN 60068-3 standard.

Three levels of alarms: acoustic, visual and remote with 0 potential contact.

The small-sized models (110 liters internal useful volume) are



suitable for environments with limited spaces and can be placed under the counter.

All models are equipped with internal Full-LED light and reversible door, blind or glass (only in the FR-G versions).

Front doors are lockable.

Models with volume 260 L are equipped with wheels.

Name	Volume (liters)	Temperature range (°C)	External dim. LxWxH (mm)	Weight (kg)	Power (W)	p/n
FR 110	110	+2 ... +8 °C	600 x 560 x 805	50	120	41500012
FR 110 G	110	+2 ... +8 °C	600 x 560 x 805	50	120	41500022
FR 260	260	+2 ... +8 °C	600 x 560 x 1525	75	160	41500032
FR 260 G	260	+2 ... +8 °C	600 x 560 x 1525	75	160	41500042

FZ FREEZER

- Temperature range: -25 ... -10 °C
- Internal volume: 110 - 260 L
- LED display

Professional laboratory freezers , with digital display and electronic control, temperature alarms, door sensor and manual defrost.

Smart refrigerated instruments, the internal parameters can be adjusted according to even the most restrictive needs.

The highly efficient compressors contain “environment friendly” ecological gases, free of CFCs and HCFCs, in compliance with the directive 2014/68 / EU.

Three levels of alarms: acoustic, visual and remote with 0 potential contact.



CALIBRATION REPORT

All ARGO Freddo FR and FZ models come with calibration report included in the price, performed with an Accredia-certified sample instrument.

Reference temperatures:

- + 5 °C FR SERIES
- - 20 °C FZ SERIES



Name	Volume (liters)	Temperature range (°C)	External dim. LxWxH (mm)	Weight (kg)	Power (W)	p/n
FZ 110	110	-25 ... -10 °C	600 x 560 x 805	50	150	41500212
FZ 260	260	-25 ... -10 °C	600 x 560 x 1525	75	190	41500232

ACCESSORIES

	p/n
Standard shelf compatible with all models	41500702
Bottom shelf compatible with all models	41500712
Overlay kit for 110lt	41500722

DATA SHEET



FR 110

FR 110 G

FR 260

FR 260 G

FZ 110

FZ 260

Volume [Liters]	110		260		110	260
Temperature range / resolution	+2,0 ... +8,0 °C / 0,1 °C				-25,0 ... -10,0 °C / 0,1 °C	
Defrost function	Auto and manual				Manual	
* Temperature variation in space	1,3 °C (a 5°C)	1,7 °C (a 5°C)	1,9 °C (a 5°C)	2,2 °C (a 5°C)	2,5 °C (a -20°C)	2,1 °C (a -20°C)
* Gradient	1,3 °C (a 5°C)	1,7 °C (a 5°C)	1,9 °C (a 5°C)	2,6 °C (a 5°C)	2,5 °C (a -20°C)	2,1 °C (a -20°C)
** Recovery time	12 min (a 5°C)	9 min (a 5°C)	18 min (a 5°C)	18 min (a 5°C)	22 min (a -20°C)	30 min (a -20°C)
Refrigeration	Dynamic (force ventilation)				Static (natural convection)	
Controller / display	Microprocessor / digital					
Power supply	220 - 240 V					
Internal dimensions (L x W x H) mm	500 x 420 x 570		500 x 450 x 1290		500 x 420 x 570	500 x 450 x 1290
External dimensions (L x W x H) mm	600 x 560 x 805		600 x 560 x 1525		600 x 560 x 805	600 x 560 x 1525
Weight	50 Kg		75 Kg		50 Kg	75 Kg
Number of shelves (supplied / max.)	3 / 3		6 / 7		3 / 3	6 / 7
Min. useful distance between shelves	13 mm					
Maximum shelf load	15 Kg					
Door	Blind	Glass	Blind	Glass	Blind	
Light	LED					
Through-hole diameter	10 mm					
Power	120 W		160 W		150 W	190 W
p/n	41500012	41500022	41500032	41500042	41500212	41500232

* In accordance with the directive EN 60068-3

** In accordance with the technical directive DIN 12880

THERMOMETERS



DATA SHEET

Sensor	Measuring range	Max tolerance	Class
THERMOCOUPLE K	-60...+1200 °C	±1,5 °C or 0,4% T*	1
THERMOCOUPLE T	-40...+350 °C	±0,5 °C or 0,4% T*	1
THERMISTOR NTC	+25...+85 °C -40...+125 °C	±0,5 °C ±1 °C	-
PT 100	-100 °C +0 °C +100 °C +200 °C	±0,35 °C ±0,15 °C ±0,35 °C ±0,55 °C	Class A
PT 100	-100 °C +0 °C +100 °C +200 °C	±0,16 °C ±0,06 °C ±0,16 °C ±0,26 °C	Class 1/5 DIN

T*=Measured temperature. Take the worst condition.

WARRANTY
3
YEARS

NEW TEMP 74

- 4 PT100 inputs
- Resolution 0,01 °C
- Measuring range: -200,0 ... +999,9 °C
- 4" color and high-definition display
- Data logger up to 190.000 data with date and time
- Three saving modes

GLP portable thermometer, with 4 channels for PT100 probes. Innovative high-resolution color display, excellent data display in all light conditions.

Possibility to select Light or Dark Theme to meet every need. "Stop-reading" functions, recording of Min and Max values. Protected calibration on 1 point for each channel independently, with indication of correction made. "Align all" function to align all channels to the reference measurement.

Ability to enter an ID for each channel. Alarms function: enable a minimum threshold and a maximum threshold.

If the temperature trespasses you will be alerted immediately by an audible and visual signal. 4-digit numeric password for data protection and calibrations. Manual, automatic and programmed data logger, up to 190,000 records with date and time. DataLink+ software can be downloaded free of charge from www.xsinstruments.com. Led and self-diagnostic messages indicate measurement status to the operator.

Powered by battery, PC, mains power supply. Auto power off.



DataLink+ software

Supplied with:

Carrying case, USB power supply, USB cable for connection to PC, batteries and operating instructions.

Name	Measuring range	Resolution	Accuracy T	p/n
NEW TEMP 74 WITHOUT PROBE	-200 ... +999 °C	0,1 °C (-99,9 ... +199,9 °C) 1 °C in the rest of the scale	±0,2 °C (-99,9 ... +99,9 °C) ±2 °C in the rest of the scale	50111212
NEW TEMP 74 + 4 PT56 TFE				50110252

TEMP 70 Vio PT100

- Resolution 0,01 °C
- Measuring range -200,0...+999,9 °C
- Dual channel PT100
- High definition backlit coloured LCD Display
- Data logger up to 1000 data
- Certifiable

GLP portable thermometer, with double channel for PT 100 probes.
Innovative high resolution color display, excellent readability in all light conditions.

“Hold” functions and recording of Min and Max values.

Protected calibration on 1 point with indication of the correction made.

Manual and automatic data logger, up to 1,000 records with date and time.

Data-Link free software downloadable on the website www.xsinstruments.com.

Guided procedures on the display for a simple and intuitive use.

LED and self-diagnosis messages indicate the status of the measurement to the operator.

Powered by battery, PC, or USB power supply. Auto shutdown.

Supplied with:

Transport case, USB power supply, USB cable for PC connection, batteries and user manual.



Model	Measuring range	Resolution	T Accuracy	p/n
TEMP 70 Vio PT100 WITHOUT PROBE	-200,0 ... +999,9 °C	0,01 °C (-99,99 ... +99,99 °C) 0,1 °C in the rest of the scale	±0,03 °C (-99,99 ... +99,99 °C) ±0,1 °C in the rest of the scale	50111082
SUPPORT	Magnetic holder for Vio series portables			50110252

TEMP 7 Vio PT100

- Resolution 0,1 °C
- Measuring range: -200 ... +999 °C
- High definition backlit coloured LCD Display
- Certifiable

Portable thermometer, for PT100 probes, with backlit color display.

Recording of Min and Max values, measure stability indicator.

Protected calibration on 1 point with indication of the correction made.

Hold function and auto-off after 20 minutes (can be disabled).

Guided procedures on the display for a simple and intuitive use.

LED and self-diagnosis messages indicate the status of the measurement to the operator.

Supplied with:

Transport case, batteries and user manual.



Model	Measuring range	Resolution	T Accuracy	p/n
TEMP 7 VIO PT100 WITHOUT PROBE	-200 ... +999 °C	0,1 °C (-99,9 ... +199,9 °C) 1 °C in the rest of the scale	±0,2 °C (-99,9 ... +99,9 °C) ±2 °C in the rest of the scale	50111012
SUPPORT	Magnetic holder for Vio series portables			50110252

TEMP 7 *Vio* NTC

- Resolution 0,1 °C
- Measuring range: -50,0 ... +150,0 °C
- High definition backlit coloured LCD Display

Portable thermometer, for NTC 30KΩ probes, with backlit color display. Recording of Min and Max values, measure stability indicator. Protected calibration on 1 point with indication of the correction made. Hold function and auto-off after 20 minutes (can be disabled). Guided procedures on the display for a simple and intuitive use. LED and self-diagnosis messages indicate the status of the measurement to the operator.

Certifiable range 0 ... 150 °C

Supplied with:



Transport case, batteries and user manual.



Models	Description	p/n
TEMP 7 Vio NTC WITHOUT PROBE	Portable thermometer	50111052
TEMP 7 Vio NTC WITH PROBE FOR AIR AND LIQUID	Portable thermometer with NT7L probe for air and liquid	50111062
TEMP 7 Vio NTC WITH PENETRATION PROBE	Portable thermometer with NT7P probe with penetration tip	50111092
SUPPORT	Magnetic holder for Vio series portables	50110252

NTC PROBES



Name	Stem length	Stem diameter	Tip	Measuring range °C	Certification range °C	t ₉₀ min	p/n
NT7L LIQUIDS AND AIR	200 mm	Ø= 3 mm		- 50 ... +150	0 ... +150	3	50011142
NT7P PENETRATION	150 mm	Ø= 4 mm		- 50 ... +150	0 ... +150	3	50011122

TEMP 7 Vio K/T

- Resolution 0,1 °C
- Measuring range: -250,0...+1.350 °C
- Certifiable
- High definition backlit coloured LCD Display

Portable thermometer, for thermocouple K/T probes, with backlit color display.
 Recording of Min and Max values, measure stability indicator.
 Protected calibration on 1 point with indication of the correction made.
 Hold function and auto-off after 20 minutes (can be disabled).
 Guided procedures on the display for a simple and intuitive use.
 LED and self-diagnosis messages indicate the status of the measurement to the operator.



Supplied with:

Transport case, batteries and user manual.

Model	Measuring range	Resolution	T Accuracy	p/n
TEMP 7 Vio K/T WITHOUT PROBE	K = -200,0 ... +1.350 °C T = -250,0 ... +400 °C	0,1 °C (-99,9...+199,9 °C) 1 °C in the rest of the scale	±0,1 % / ±0,4 °C reading > -150 °C ±0,25 % / ±1 °C reading < -150 °C	50111032
SUPPORT	Magnetic holder for Vio series portables			50110252



XS Portable thermometers brochures are available on our website www.xsinstruments.com

PT100 PROBES



PROBES WITH HANDLE



Name	Stem length	Stem diameter	Tip	Measuring range °C	Certification range °C	t ₉₀ min	Precision class	p/n
PT56 L LIQUID AND AIR	200 mm	Ø= 3 mm		-50 ... +400	-50 ... +250	2	A	51000202
PT56 C CONTACT	200 mm	Ø= 5 mm		-50 ... +400	0 ... +250	3	A	51000212
PT56 P PENETRATION	150 mm	Ø= 4 mm		-50 ... +400	-50 ... +250	2	A	51000222
PT56 A AIR	200 mm	Ø= 4 mm		-50 ... +250	-50 ... +150	2	A	51000232
PT56 L 1/5 DIN	200 mm	Ø= 3 mm		-50 ... +400	-50 ... +300	2	1/5 DIN	51000242
PT56 /500 LIQUIDS AND AIR	500 mm	Ø= 6 mm		-50 ... +400	-50 ... +300	5	A	51000262
PT56 /1000 LIQUIDS AND AIR	1000 mm	Ø= 6 mm		-50 ... +400	-50 ... +300	5	A	51000272

PROBES WITHOUT HANDLE- PERFECT FOR OVEN AND INCUBATORS



Name	Stem length	Stem diameter	Tip	Measuring range °C	Certification range °C	t ₉₀ min	Precision class	p/n
PT56 TFE LIQUIDS AND AIR	100 mm	Ø= 4 mm		-200... +300 cable included	-200 ... +200	3	A	51000252
PT56 TFE 1/5 DIN LIQUIDS AND AIR	100 mm	Ø= 4 mm		-200... +300 cable included	-200 ... +200	3	1/5 DIN	51000292

TERMOCOUPLE PROBES K

PROBES WITH HANDLE

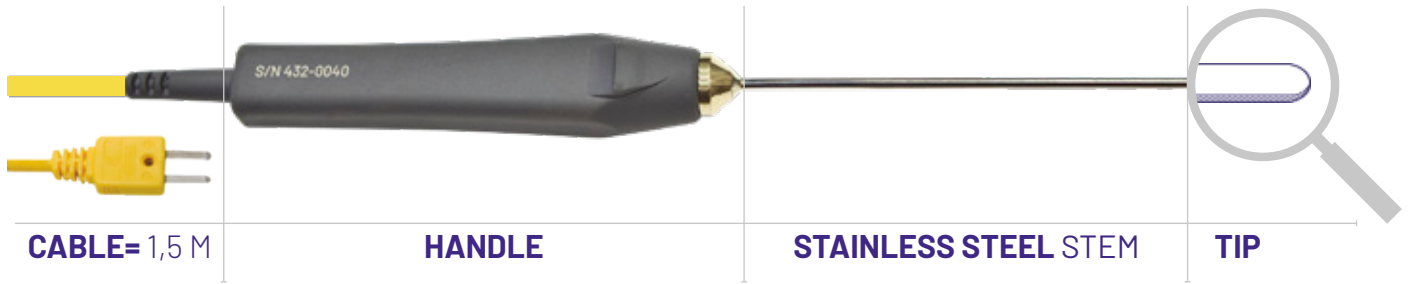

Name	Stem length	Stem diameter	Tip	Measuring range °C	Certification range °C	t ₉₀ min	Precision class	p/n
3K 220 LIQUIDS AND AIR	200 mm	∅= 2 mm		-60 ... +600	0 ... +400	2	1	51000752
3K 320	200 mm	∅= 3 mm		-60 ... +800	0 ... +550	3	1	51000762
3K 350	500 mm	∅= 3 mm		-60 ... +800	0 ... +800	2	1	51000772
3K 6100	1000 mm FOLDING	∅= 6 mm		-60 ... +1100	0 ... +1100	4	1	51000782
3K 6120	1200 mm FOLDING	∅= 6 mm		-60 ... +1100	0 ... +1100	6	1	51000822
3K 650	500 mm FOLDING	∅= 6 mm		-60 ... +1100	0 ... +1100	7	1	51000792
3K 415 P PENETRATION	150 mm	∅= 4 mm		-50 ... +600	0 ... +550	2	1	51000832
3K 520 C CONTACT	200 mm	∅= 5 mm		-60 ... +600	0 ... +250	2	1	51000802

PROBES WITHOUT HANDLE - PERFECT FOR TUBES AND HARD PLACES TO REACH

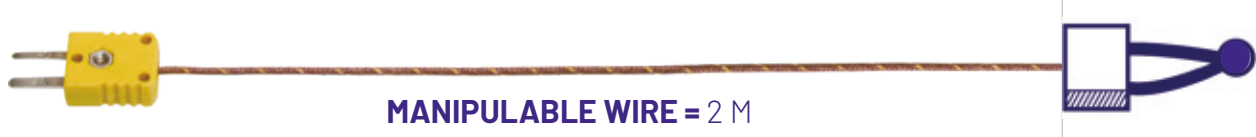





Name	Stem length	Stem diameter	Tip	Measuring range °C	Certification range °C	t ₉₀ min	Precision class	p/n
3K 1200 MANIPULABLE WIRE	2000 mm	∅= 2 mm		-60 ... +400	0 ... +300	1	1	51000812

TERMOCOUPLE PROBES T

PROBES WITH HANDLE SUGGESTED FOR FOOD AND PHARMACEUTICAL INDUSTRY



Name	Stem length	Stem diameter	Tip	Measuring range °C	Certification range °C	t ₉₀ min	Precision class	p/n
3T 320 LIQUIDS AND AIR	200 mm	∅= 3 mm		-50 ... +350	0 ... +300	3	1	51000902
3T 415 PENETRATION	150 mm	∅= 4 mm		-50 ... +350	0 ... +300	2	1	51000912
3T 215 PENETRATION	150 mm	∅= 2 mm		-50 ... +350	0 ... +300	1	1	51000942
3T 520 C CONTACT	200 mm	∅= 5 mm		-50 ... +350	0 ... +250	2	1	51000922
3T 420 A AIR	200 mm	∅= 4 mm		-50 ... +250	0 ... +200	2	1	51000932

PROBES WITHOUT HANDLE - PERFECT FOR OVEN AND INCUBATORS

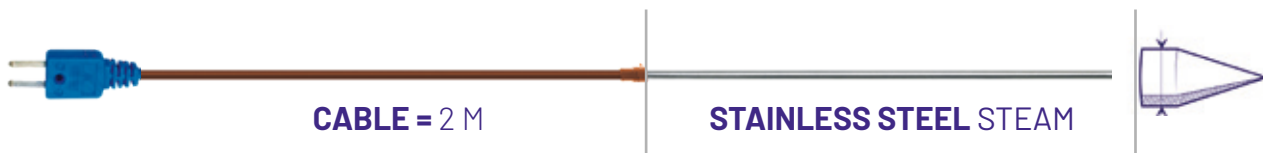

Name	Stem length	Stem diameter	Tip	Measuring range °C	Certification range °C	t ₉₀ min	Precision class	p/n
3T 210	100 mm	∅= 2,5 mm		-50 ... +300	-40 ... +250	2	1	51000952

MINI 1 WAY

- Data logger Single Trip
- Working range : -40...+80 °C



Data logger with 1 channel, IP65 protection with internal temperature sensor.

Active LED (OK) and 4 LED for the 4 alarm thresholds.

Start with START button. Start button used also to mark an event.

Mini 1 Way: Memory up to 45.000 savings (interval 5 sec ... 24 hours).

Mini 1 Way LCD : memory up to 20.000 savings.

Internal battery (1 year battery life).

Working range: -40...+80 °C. **Resolution** 0,01°C. **Temperature accuracy** ±0,3°C (-10...+80°C), ±0,5°C (-40...-10°C).

Name	Description	Qty	p/n
MINI 1 WAY PREPROGRAMMED	Preprogrammed with alarm thresholds (LL = 0 °C, L = 2 °C, H = 8 °C, HH = 10 °C), 5 minute acquisition interval, STOP button not activated.	10 pcs	70101013
MINI 1 WAY PROGRAMMABLE ON REQUEST	Provide to Giorgio Bormac alarm thresholds with delays, the acquisition interval, and the activation or not of the STOP button.	10 pcs	70101003
MINI 1 WAY LCD CON DISPLAY	Provide to Giorgio Bormac alarm thresholds with delays, the acquisition interval, and the activation or not of the STOP button.	10 pz	70101043

MINI T - T1 - TH - TB

- Working range T : -40...+80 °C
- Working range H : 0...100 % RH
- Resolution : 0,01 °C - 0,01 % RH
- Memory : 48000 measurements



Temperature data logger. IP65 protection.

1 channel with internal or external sensor, and multifunction display for viewing: **current value and minimum, maximum**

and average temperature, time spent by the logger outside the set thresholds. Marking an event on the logger via the Start button. Ability to store 48,000 measurements (interval 5 sec ... 24 hours). Internal battery (1 year battery life) replaceable. Start with START button with delayed start option. STOP button activated via software to manually stop the recording.

USB for connection to PC.

The MINI T1 Data Logger is equipped with an external pointed steel probe, Ø 4mm L = 80mm, with 1 meter cable.

Suitable for detections inside freezers.



Name	Range	Resolution	Accuracy	p/n
MINI T INTERNAL TEMPERATURE SENSOR	T: - 40 ...+80 °C	0,01 °C	T: ±0,3°C (-10...+80°C) / ±0,5°C (-40...-10°C)	70100003
MINI T1 EXTERNAL TEMPERATURE SENSOR	T: - 40 ...+80 °C	0,01 °C	T: ±0,3°C (-10...+80°C) / ±0,5°C (-40...-10°C)	70100103
MINI TH INTERNAL SENSOR TEMPERATURE + HUMIDITY	T: - 40 ...+80 °C H: 10...90 % RH	0,01 °C 0,01 % RH	T: ±0,3°C (-10...+80°C) / ±0,5°C (-40...-10°C) H: ±3%RH (+15 ... 25 °C) / ± 5% elsewhere	70100203
MINI TB WITH PROBE	T: - 200 ...+150 °C	0,01 °C	T: ±0,3°C (-10...+130°C), ±0,5°C (elsewhere), ±3°C (+150 ... +200 °C)	70100303
PROBE FOR MINI TB	Pointed steel probe, Ø 4mm L = 80mm, 1 meter cable.			70103013
DBAT MINI BATTERY	DBAT Mini replacement batteries for Mini XS			70109993

Note

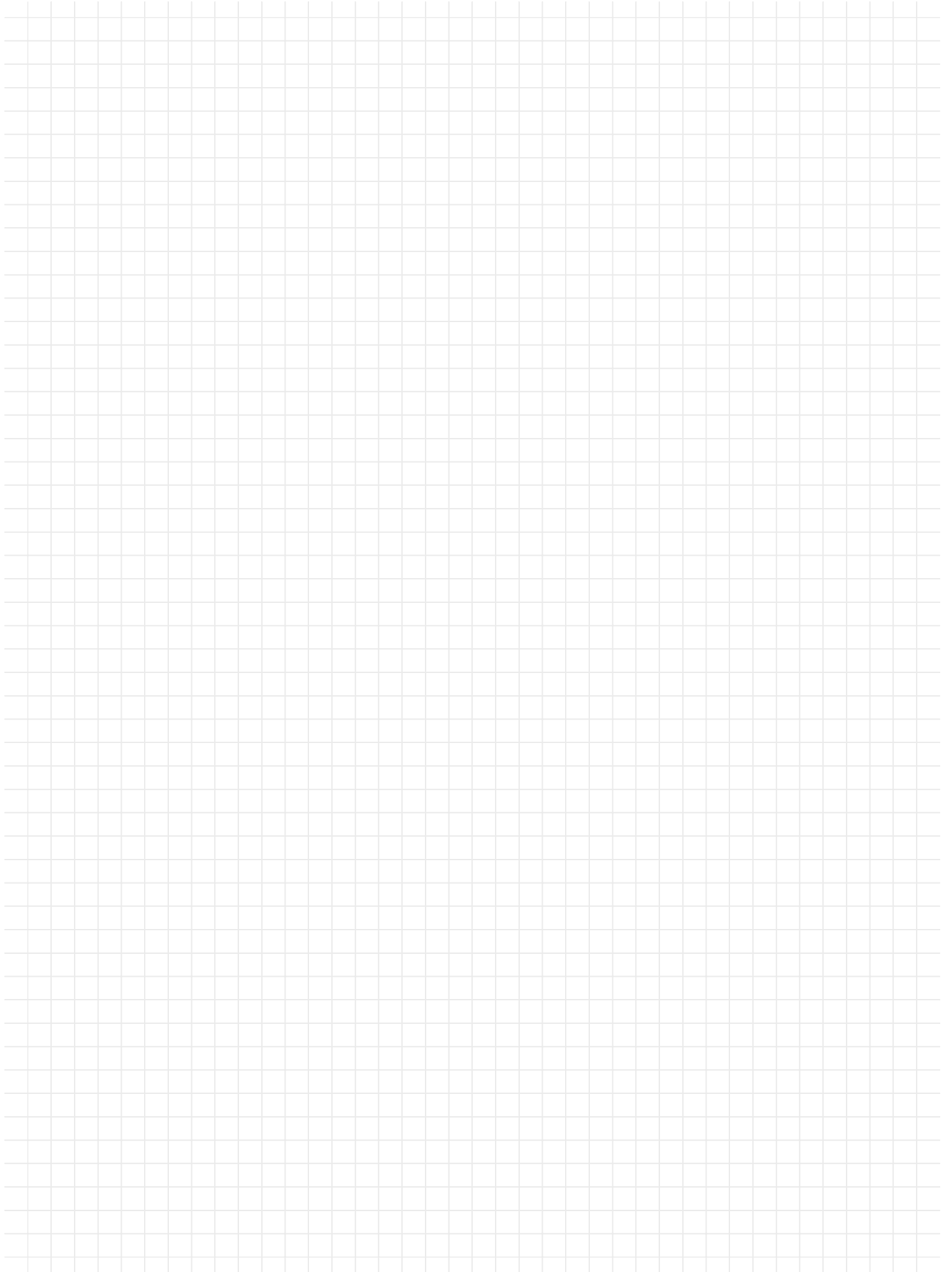

SPECTROPHOTOMETERS

VIS AND UV/VIS



Touchscreen

A 5" TFT high definition color display for a new level of experience. Easy user interface, built-in features (photometry, quantitation, spectrum scan). In addition: File management, System Utility and Performance verification.



Connectivity and Storage

USB Flash Drive connection for data and methods storage. PC remote control, RS-232 port for printer connection. Internal memory to save methods and data.



Access and maintenance

Removable front panel, anticorrosive material cell holder, drain hole inside the sample compartment: designed to protect the instrument from accidental spills, time wear and damages.



Lamp compartment

Removable top panel for an easier and faster access to the sources compartment, for a rapid inspection of the lamps, check of alignment and lamp replacement.



Multi-language user interface

Select your preferred language to improve the interactivity with Onda Touch instruments. Available languages: English, German, Spanish, French, Italian and Portuguese.

UV-31 SCAN

- UV / VISIBLE
- Coloured Display 5" TOUCH SCREEN
- Range 190 - 1100 nm
- Bandwidth 2 nm



Single beam UV/VISIBLE spectrophotometer. 2 nm bandwidth, single beam, Tungsten/Deuterium lamps. USB flash memory, operating system multi-language.

Functions: photometry, quantitative, spectrum scan, file management, performance verification

External dimensions (LxWxH) 456x360x185mm. Weight 10.7 kg.
Power supply 100 - 240 V AC - 50/60 Hz - Power: 120 W

Supplied as standard: 4 optical glass cuvettes o.p. 10 mm, 2 quartz cuvettes o.p. 10 mm, 4-position cell holder (10 mm), power cable, dust cover, USB flash memory, calibration report and Easy UV Basic software (allowing Quantitative, Single λ Photometric, Kinetic analysis).

Name	Range	Bandwidth	Beam	Source	p/n
UV-31 SCAN	190 - 1100 nm	2 nm	Single	Tungsten/Deuterium	11000082

V-11 SCAN

- VISIBLE
- Coloured Display 5" TOUCH SCREEN
- Range 320 - 1100 nm
- Bandwidth 4 nm



VISIBLE single beam spectrophotometer. 4 nm bandwidth, single beam, Tungsten lamp, USB flash memory, operating system multi-language.

Functions: photometry, quantitative, spectrum scan, file management, performance verification.

External dimensions (LxWxH) 456x360x185mm. Weight 10.5 kg.
Power supply 100 - 240 V AC, 50/60 Hz - Power 75 W.

Supplied as standard: 4 o.p. 10 mm optical glass cuvettes, 4-position cell holder (10 mm), power cable, dust cover, USB flash memory, calibration report and Easy UV Basic software (allowing Quantitative, Single λ Photometric, Kinetic analysis).

Name	Range	Bandwidth	Beam	Source	p/n
V-11 SCAN	320 - 1100 nm	4 nm	Single	Tungsten	11000062

UV-21

- UV / VISIBLE
- Coloured Display 5" TOUCH SCREEN
- Range 195 - 1050 nm
- Bandwidth 4 nm



Single beam UV/VISIBLE spectrophotometer. 4 nm bandwidth, single beam, Tungsten/Deuterium lamps. USB flash memory, operating system multi-language.

Functions: photometry, quantitative, file management, performance verification

External dimensions (LxWxH) 456x360x185mm. Weight 10.7 kg
Power supply 100 - 240 V AC - 50/60 Hz - Power: 120 W

Supplied as standard: 4 optical glass cuvettes o.p. 10 mm, 2 quartz cuvettes o.p. 10 mm, 4-position cell holder (10 mm), power cable, dust cover, USB flash memory, calibration report and Easy UV Basic software (allowing Quantitative, Single λ Photometric, Kinetic analysis)

Name	Range	Bandwidth	Beam	Source	p/n
UV-21	195 - 1050 nm	4 nm	Single	Tungsten/Deuterium	11000072

SOFTWARE EASY UV FOR ONDA TOUCH SERIES

Easy UV is the application software based on Windows operating systems for the remote control of ONDA touch Series instruments. The application range, data analysis and file management function are greatly expanded, for example to clinical applications (hemoglobin oxygen saturation) and basic biotechnology research (UV methods for DNA/proteins, range DNA 0,2-70 $\mu\text{g/ml}$).

Functions:

Photometry, Quantitative, Kinetics, Multi-wavelength, Spectrum scan, DNA/protein (UV methods), Wine color analysis.

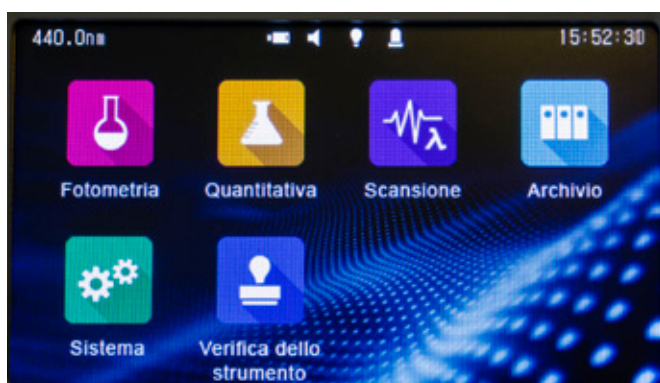

Main Menu
Onda TOUCH

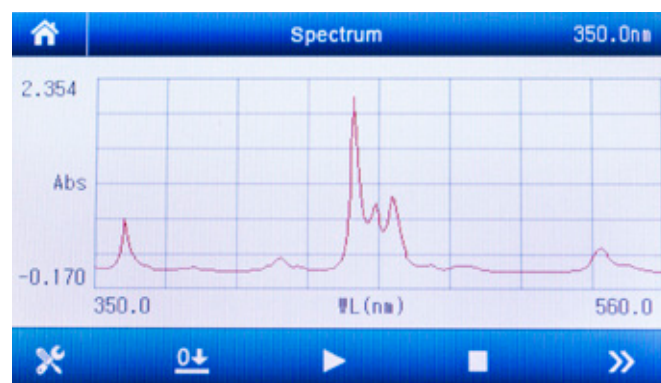









Graphic visualization of a spectrum scan

ACCESSORIES

Name	Description	p/n
EASY UV SOFTWARE	For OS Windows, includes the functions: Photometry, Quantitative, Kinetics, Multi-wavelength, Spectrum scan, DNA/protein (UV methods), Wine color analysis. Includes USB installation key, USB cable, USB dongle user license, user manual	11000972
MICRO PRINTER RS 232	Supplied with power supply, RS232 connection cable, roll of normal paper	11000442
IQ-00 MANUAL	IQ-00 paper manual for ONDA spectrophotometers. Filled in by Giorgio Bormac staff to order separately (cod. 11000959)	11000192
VISIBLE SOURCE REPLACEMENT LAMP	VISIBLE range source. Tungsten-halogen lamp. Vertical filament. Compatible with V-10 Plus , UV-20 and UV-30 SCAN models.	11000912
VISIBLE SOURCE REPLACEMENT LAMP	VISIBLE range source. Tungsten-halogen lamp. Horizontal filament. Compatible with V-11 SCAN, UV-21 and UV-31 SCAN models.	11000942
UV SOURCE REPLACEMENT LAMP	UV range source. Deuterium lamp. Compatible with all ONDA models.	11000922
ADAPTOR TUBES 1 mm	Adaptor 10x10 for optical path tubes 1 mm Min. quantity order: 2 pcs	11000582
DUST COVER	for ONDA spectrophotometer	11000932

SUPPORTS

Description		p/n
4 position cell holder for up to 10 mm square cuvettes		11000202
4 position cell holder for up to 50 mm square cuvettes		11000212
4 position cell holder for up to 100 mm square cuvettes		11000222
Single position cell holder for micro-cells ,central beam height: 15 mm		11000232
5° Reflectance measurements Support (minimum sample: 20mmx20mmx4mm, central beam height: 50mm)		11000412
Single position Solid sample holder (dimensions 50x30x2mm)		11000422
8 position automatic cell holder for up to 10 mm optical path square cuvettes		11000242
5 position automatic cell holder for 10mm-100mm optical path cuvettes		11000432
Test tube holder Ø 16mm , max height: 90mm, central beam height: 45mm		11000532

OPTICAL GLASS CELLS FOR VISIBLE - RANGE 320 - 1400 nm

Description	Dimensions (L x W x H) mm	Volume ml	p/n
Special optical glass cuvettes, 1 mm optical path. 2-piece set	12,5 x 3,5 x 45	0,4	11000382
Special optical glass cuvettes, 10 mm optical path. 4-piece set	12,5 x 12,5 x 45	3,5	11000252
Special optical glass cuvettes, 20 mm optical path. 4-piece set	12,5 x 22,5 x 45	7	11000262
Special optical glass cuvettes, 30 mm optical path. 4-piece set	12,5 x 32,5 x 45	10,5	11000272
Special optical glass cuvettes, 50 mm optical path. 4-piece set	12,5 x 52,5 x 45	17,5	11000282
Special optical glass cuvettes, 100 mm optical path. 4-piece set	12,5 x 102,5 x 45	35	11000292
Flow cuvette made of special optical glass, optical path 10 mm Beam height at 15 mm. Micro-cell holder required cod.11000232	12,5 x 12,5 x 45	0,7	11000492

QUARTZ CELLS FOR UV - RANGE 190 - 1400 nm

Description	Dimensions (L x W x H) mm	Volume ml	p/n
Quartz glass cuvettes, 1 mm optical path. 2 pieces	12,5 x 3,5 x 45	0,4	11000522
Square quartz glass cuvettes, 10 mm optical path. 2-piece set	12,5 x 12,5 x 45	3,5	11000302
Quartz glass cuvettes, 20 mm optical path. 2-piece set	12,5 x 22,5 x 45	7	11000312
Quartz glass cuvettes, 30 mm optical path. 2-piece set	12,5 x 32,5 x 45	10,5	11000322
Quartz glass cuvettes, 50 mm optical path. 2-piece set	12,5 x 52,5 x 45	17,5	11000332
Quartz glass cuvettes, 100 mm optical path. 2-piece set	12,5 x 102,5 x 45	35	11000342



SPECIAL CELLS- MICRO-CELLS HOLDER REQUIRED Part. No.11000232

Description	Dimensions (L x W x H) mm	Volume μ l	p/n
MICRO quartz glass cuvette, optical path 10 mm	12,5 x 12,5 x 45	100	11000352
MICRO quartz glass cuvette, optical path 10 mm	12,5 x 12,5 x 45	200	11000362
MICRO quartz glass cuvette, optical path 10 mm	12,5 x 12,5 x 45	500	11000372
MICRO quartz glass cuvette, optical path 10 mm	12,5 x 12,5 x 45	1000	11000392
Flow cuvette made of special optical glass , optical path 10 mm (beam height 15 mm)	12,5 x 12,5 x 45	700	11000492
Quartz glass flow cuvette, optical path 10 mm (beam height 15 mm)	12,5 x 12,5 x 45	700	11000502

Quartz
100-200 μ lQuartz
500-1000 μ l

Flow cuvette

SIPPER and PELTIER SYSTEM



Name	Description	p/n
SIPPER A-1101 FLOWING SYSTEM	Flow cell system, complete with external unit, power cable, connection cable, micro-cell holder, quartz flow cell, silicone flow tubes, adjustable flow rate from 1 to 8 ml/min . External dimensions (LxWxH) 170x270x115mm. Weight 3 kg. Power 240 V AC, 50/60 Hz	11000552
PELTIER A-1201 THERMOSTATIC SYSTEM	System for selectable constant temperature range 10-60°C , complete with outdoor unit, power cable, connection cable, special micro-cell thermostatic stand. External dimensions (LxWxH) 170x270x115mm. Weight 3kg. Power 240 V AC, 50/60 Hz NO CUVETTE INCLUDED.	11000562
SIPPER / PELTIER A-1001 COMBINED SYSTEM	Selectable constant temperature and flow cell system. Range 10-60°C, flow rate adjustable from 1 to 8 ml/min. Complete with external unit, power cord, connection cable, special thermostatically finned micro-cell holder, quartz flow cell, silicone flux tubes. External dimensions (LxWxH) 170x270x115mm. Weight 3 kg. Power supply 240 V AC, 50/60 Hz	11000572

CALIBRATION REPORT

All Onda spectrophotometers are supplied with a calibration report performed according to ISO 17025 requirements, to measure with traceability.

On the calibration report are reported:

- **WAVELENGTH ACCURACY**
- **PHOTOMETRIC ACCURACY**
- **STRAY LIGHT TEST**
- **MEASUREMENT UNCERTAINTY**
- **TRACEABILITY STATEMENT**

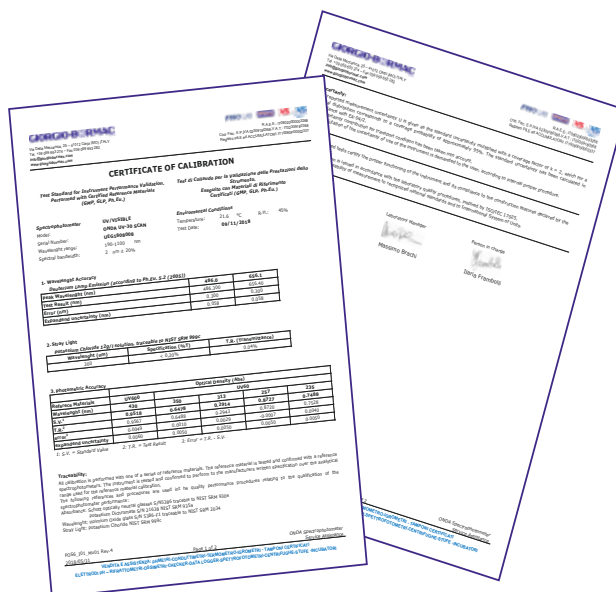

V-10 PLUS

- VISIBLE Single beam
- Range 325 - 1000 nm
- Bandwidth 4 nm



VISIBLE single beam spectrophotometer.
Single beam optical system, 4 nm bandwidth, Tungsten lamp.
LCD display, membrane keypad.

Spectral resolution 0.1 nm,
Photometric accuracy $\pm 0.5\%T$,
Photometric accuracy $\pm 0.3\%T$.
Photometric range 0...200%T, -0.3...3Abs, 0...1999Conc.

Functions: Transmittance, Absorbance, Concentration, Coefficients

External dimensions (LxWxH) 490x360x210mm. Weight 12 kg.
Power 100 - 240 V AC, 50/60 Hz. Power 75 W.

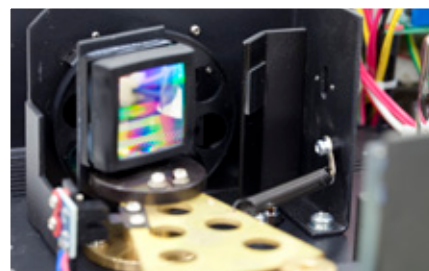

Monochromator:
1200 lines/mm reticle

Supplied as standard:

Complete with slide cell holder for 4 x 10 mm o.p. cuvettes, 4 x 10 mm special optical glass square cuvettes, EU power cord, MWave Basic Software (allowing Quantitative, Single λ Photometric, Kinetic analysis), dust cover, calibration report.

Name	Range	Bandwidth	Beam	Source	p/n
V-10 PLUS	325 - 1000 nm	4 nm	Single	Tungsten	11000052

ACCESSORIES FOR V-10 PLUS

Name	Description	p/n
PRO-WINE SOFTWARE	Software for V-10 PLUS (Includes the installer CD, USB cable, USB dongle usage license key, User manual). Necessary PC with Windows operating system and two USB ports.	11000962
MICRO PRINTER RS 232	Thermal paper, supplied with power supply, connection cable, paper roll	11000452
MANUAL IQ-00	Paper manual IQ-00 for ONDA spectrophotometer. Filled in by Giorgio Bormac staff to order separately (part no. 11000959)	11000192
VISIBLE SOURCE REPLACEMENT LAMP	VISIBLE range Source. Tungsten-Halogen Lamp. Horizontal filament. Compatible with V-10 Plus, UV-20 and UV-30 Scan models	11000912
ADAPTOR TUBES 1mm	Adaptor 10x10 for optical path tubes 1 mm Min. quantity order: 2 pcs	11000582

SUPPORTS

Description	p/n
Cell support 4 positions , optical path cuvettes up to 10 mm	11000202
Cell support 4 positions , optical path cuvettes up to 50 mm	11000212
Cell support 4 positions , optical path cuvettes up to 100 mm	11000222
Microcell holder, 15 mm beam height, one position	11000232
Cell holder for test tubes (Ø 8 to 24 mm , max. height 100 mm , radius height 45 mm) only for V-10 PLUS	11000402
Support for 5° reflectance measurements (20 x 20 x 4 mm sample)	11000412
Stand for solid sample (size 50 x 30 x 2 mm), one position	11000422

CUVETTES FOR VISIBLE - RANGE 320 - 1400 nm

Description	Dimensions (W x L x H) mm	Volume ml	p/n
Special optical glass cuvettes, 1 mm optical path. 2-piece set	12,5 x 3,5 x 45	0,4	11000382
Square cuvettes made of special optical glass, optical path 10 mm . 4-piece set	12,5 x 12,5 x 45	3,5	11000252
Special optical glass cuvettes, 20 mm optical path. 4-piece set	12,5 x 22,5 x 45	7	11000262
Special optical glass cuvettes, 30 mm optical path. 4-piece set	12,5 x 32,5 x 45	10,5	11000272
Special optical glass cuvettes, 50 mm optical path. 4-piece set	12,5 x 52,5 x 45	17,5	11000282
Special optical glass cuvettes, 100 mm optical path. 4-piece set	12,5 x 102,5 x 45	35	11000292
Flow cuvette made of special optical glass, optical path 10 mm (beam height at 15 mm). Micro-cell holder required cod.11000232	12,5 x 12,5 x 45	0,7	11000492



1 mm



10 mm



20 mm



30 mm



50 mm



100 mm



ONDA brochure is available on our website
www.giorgiobormac.com

REFRACTOMETERS

WARRANTY
2
YEARS



A refractometer is an optical measuring instrument used to determine the refractive index of a substance, or some physical property of a substance that is directly related to its refractive index.

It can be used to establish the identity of an unknown substance based on its refractive index, to establish the purity of a particular substance or to determine the concentration of one substance dissolved in another.

Commonly the refractometers are used to measure fluid concentrations such as the sugar content (Brix level) of fruits, vegetables, juices and carbohydrate drinks or for cutting fluids, specific gravity of urine, concentration of protein in the blood, degree of moisture in the honey (myelometer), salinity, antifreeze properties, industrial fluids.

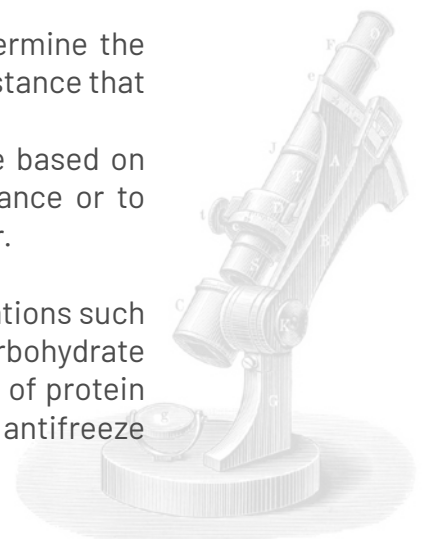

DBR 95

- Measuring range 0,0..95,0 % Brix
- Simultaneous display of brix, temperature and refractive index

Portable and benchtop digital refractometer.

Automatic temperature compensation.

Self-calibrating system with distilled water.

Sample volume 1ml.

Programmable MIN/MAX alarm threshold.

Powered by 3,7 V rechargeable battery.

Working range

BRIX = 0,0..95,0 % Brix ($\pm 0,3$ %),

Refractive index = 1,3330...1,5318 nD,

Temperature = 0..40 °C ($\pm 0,1$ °C).



Always equipped with:

Carrying case, power supply and USB cable, user manual.

Name	Description	Measuring range	Accuracy	p/n
DBR 95	Benchtop digital refractometer	0,0 - 95,0 % Brix	$\pm 0,3$ %	44000063

DBR 55 / DBR SAL

- Measuring range: 0,0..55,0 % Brix
- Salinity measuring range: 0,0..28,0 % NaCl

Portable and bench-top waterproof digital refractometer.

Backlit display.

Automatic temperature compensation 10.0..60.0 °C.

Self-calibrating with water. 0.5 ml sample volume.

Stores up to 20 data, with cyclic memory.

Rubber shell and hard case.

Power supply 2 x 1.5 V (AAA Alkaline).

Dimensions 58 x 36 x 122 mm. Weight 150 g.



Name	Description	Measuring range	Accuracy	p/n
DBR 55	Benchtop digital refractometer	0,0..55,0 % Brix	$\pm 0,2$ %	44000073
DBR SAL	Salinity digital refractometer	0,0..28,0 % NaCl	$\pm 0,2$ %	44000053

DBR WINE

- Measuring range 0,0..55,0 % Brix

Portable and bench-top waterproof digital refractometer. Backlit display.
Automatic temperature compensation 10.0..60.0 °C.
Self-calibrating with water.
 Sample volume 0.5 ml. Rubber shell and hard case.
 Power supply 2 x 1.5 V (AAA Alkaline). Dimensions 58 x 36 x 122 mm. Weight 150 g.

RANGE	Measuring range	Resolution
Brix	0.0 ~ 55.0%	0,1 %
Temperature	0°C ~ 70°C	0,1°
Bé (Baumé)	0.0° ~ 29.8°	0,1°
Babo	0.0° ~ 46.4°	0,1°
Oe (Oechsle)	0° ~ 256°	1°
TAVP *	0.0% ~ 37,9%	0,1 %

* ALCOHOL CONTENT BY VOLUME

Name	Description	Measuring range	Accuracy	p/n
DBR WINE	Benchtop digital refractometer	0,0..55,0 % Brix	±0,2 %	44000093



DBR COFFEE

App HMCoffee



- Measuring range 0,00..26,00 % Brix
- Bluetooth connection: downloadable App for data storage.

Portable and bench-top waterproof digital refractometer. Backlit display.
Automatic temperature compensation 10.0..60.0 °C.
Self-calibrating with water. Sample volume 0.5 ml.
 Rubber shell and hard case. Power supply 2 x 1.5 V (AAA Alkaline).
 Dimensions 58 x 36 x 122 mm. Weight 150 g.

Measuring range

BRIX= 0,00..26,00 % Brix (±0,20 %),

TDS= 0,00..23,00 % TDS (±0,1 %),

Temperature = 0..70 °C (±0,1 °C).



Name	Description	Measuring range	Accuracy	p/n
DBR COFFEE	Benchtop digital refractometer	0,00..26,00 % Brix	±0,20 %	44000083

OPTICAL REFRACTOMETERS



Lid with led

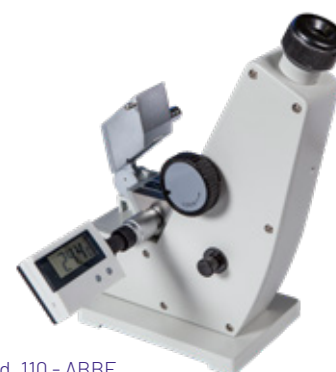

mod. 110 - ABBE

All refractometers are supplied with hard case and calibration screwdriver.

Model	Measuring range	Features	p/n
110 ABBE	Brix: 0,0 - 95,0 % ($\pm 0,25\%$) nD: 1,3000 - 1,7000 ($\pm 0,0002$)	Bench refractometer with thermostatable prism. Complete with digital thermometer and calibration prism	43000133
THERMOMETER DIGITAL FOR ABBE	Replacement thermometer for Abbe 110		43000153

Model	Measuring range (% BRIX)	Features	p/n
101	Brix: 0-32 % ($\pm 0,2\%$)		43000013
101 ATC	Brix: 0-32 % ($\pm 0,2\%$)	Automatic temperature compensation	43000103
101 ATC LED	Brix: 0-32 % ($\pm 0,2\%$)	Automatic temperature compensation	43000203
102	Brix: 28-62% ($\pm 0,2\%$)		43000023
103	Brix: 0-80 % ($\pm 0,5\%$)		43000033
103 LED	Brix: 0-80 % ($\pm 0,5\%$)		43000223
104 HONEY	Brix : 58-92% Water : 12-27% Be : 38-43°	Triple scale	43000043
105 CLINIC	Serum : 0-12 g/dL Urine specific gravity:1000 - 1050 nD Refraction index:1,3330 - 1,3600	Triple scale	43000053
106 SALINITY	Sodium Chloride: 0-28% ($\pm 0,2\%$)		43000063
106 ATC SALINITY	Sodium Chloride: 0-100 ‰ Specific gravity: 1000-1070	Double scale Automatic temperature compensation	43000113
107 ATC WINE	Brix: 0-35 % Babo: 0-28%	Double scale Automatic temperature compensation	43000123
107 ATC LED WINE	Brix: 0-35 % Babo: 0-28%	Double scale Automatic temperature compensation	43000233
414 ATC ANTIFREEZE BATTERIES	Ethylene glycol: -50 °C / 0 °C Propylene glycol: -50 °C / 0 °C Cleaner: -40 °C / 0 °C Batteries fluid: 1.10 / 1.40 sg.	Automatic temperature compensation	43000173
UREA	Brix: 0-40 %	Signal mark at 32,5% Brix	43000193

Accessories			p/n
LID	Spare part lid for telescope refractometers without lighting		43000163
LID WITH LED	Spare part lid with LED lighting It allows a perfect reading even if there's low or no lighting The cover is interchangeable and can be installed on all the optical refractometers models.		43000003

INDEX BY CODE

p/n	DESCRIPTION		NOTE
11000052	ONDA V-10 PLUS Spectrophotometer, range 325 - 1000 nm, bandwidth 4 nm, single beam, digital wavelength set	137	
11000062	ONDA TOUCH V-11 SCAN Spectrophotometer, TOUCH SCREEN color display, range 320 - 1100 nm, bandwidth 4 nm	132	
11000072	ONDA TOUCH UV-21 Spectrophotometer, TOUCH SCREEN color display, range 195 - 1050 nm, bandwidth 4 nm	133	
11000082	ONDA TOUCH UV-31 SCAN Spectrophotometer, TOUCH SCREEN color display, range 190 - 1100 nm,	132	
11000192	IQ-OQ-PQ Paper Manual	134	
11000212	4-cell holder for up to 50x10mm square cuvette	134	
11000222	4-cell holder for up to 100x10mm square cuvette	134	
11000232	Cell holder for micro-cells 10x10mm (central beam height: 15mm)	134	
11000242	8-position AUTO cell changer for 10mm square cuvette	134	
11000252	Square cuvettes, optical glass, 10mm path, 12.5x12.5x45mm. Set of 4 pcs	135	
11000262	Square cuvettes, optical glass, 20mm path, 12.5x22.5x45mm. Set of 4 pcs	135	
11000272	Square cuvettes, optical glass, 30mm path, 12.5x32.5x45mm. Set of 4 pcs	135	
11000282	Square cuvettes, optical glass, 50mm path, 12.5x52.5x45mm. Set of 4 pcs	135	
11000292	Square cuvettes, optical glass, 100mm path, 12.5x102.5x45mm. Set of 4 pcs	135	
11000302	Square cuvettes, quartz, 10mm path, 12.5x12.5x45mm. Set of 2 pcs	135	
11000312	Square cuvettes, quartz, 20mm path, 12.5x22.5x45mm. Set of 2 pcs	135	
11000322	Square cuvettes, quartz, 30mm path, 12.5x32.5x45mm. Set of 2 pcs	135	
11000332	Square cuvettes, quartz, 50mm path, 12.5x52.5x45mm. Set of 2 pcs	135	
11000342	Square cuvettes, quartz, 100mm path, 12.5x102.5x45mm. Set of 2 pcs	135	
11000352	Micro-cell 100 µl, quartz, 10mm	135	
11000362	Micro-cell 200 µl, quartz, 10mm	135	
11000372	Micro-cell 500 µl, quartz, 10mm	135	
11000382	Square cuvettes, optical glass, 1mm path, 12.5x3.5x45mm. Set of 2 pcs	135	
11000392	Micro-cell 1000 µl (1ml), quartz, 10mm	135	
11000402	Test tube holder (diameter 8-24mm; max height: 110mm; central beam height: 35mm)	138	
11000412	5° REFLECTANCE MEACHMENT ATTACHMENT (minumim sample: 20x20mm, central beam height: 50mm)	138	
11000422	SOLID sample holder (sample 50x30x2mm)	138	
11000432	5 position 10-100mm cuvette AUTOMATIC holder (for ONDA TOUCH SERIES spectrophotometers)	134	
11000442	Micro Printer for ONDA TOUCH Series Spectrophotometers (RS232, normal paper roll)	134	
11000452	Thermal printer for ONDA spectrophotometer V10 PLUS	137	
11000492	Flow cell, 10mm, optical GLASS (central beam height: 15mm)	135	
11000502	Flow cell, 10mm, QUARTZ (central beam height: 15mm)	135	
11000522	Square cuvette, quartz, 1mm path, 12.5x3.5x45mm, 1 piece	135	
11000532	Test tube holder (diameter 16mm H max 90mm) for ONDA TOUCH SERIES	134	
11000552	A-1101 Sipper System, Holder beam height: 15mm, including: pump unit, micro-cell holder, flow cell, pipes.	136	
11000562	A-1201 Peltier System, constant-Temperature (Holder beam height: 15mm), including: Peltier unit, peltier micro-cell	136	
11000572	A-1001 Combined Peltier/Sipper System (Holder beam height: 15mm), including: Peltier/sipper unit, peltier micro	136	
11000582	Adapter 10X10 for cuvettes 1 mm path. Minimun order 2 pieces	137	
11000912	Tungsten-alogen lamp, 12V/20W (VISIBLE range)	137	
11000922	Deuterium lamp (UV range)	134	
11000932	Dust cover for ONDA spectrophotometer	134	
11000962	ONDA PC Software Pro-WINE color Version (CD, USB cable, USB dongle) ONLY FOR V-10 PLUS	137	
11000972	ONDA TOUCH PC Software Pro (CD, USB cable, USB dongle) FOR ONDA TOUCH models	134	
15100053	Argo-Filler, up to 8 speed selectable	96	
15100573	Filters for Argo-Filler, 1X10 pieces	96	

p/n	DESCRIPTION		NOTE
22002013	M2-A Magnetical Stirrer with heating, stainless steel plate, capacity 20 liters. Speed: up to 1.500 RPM	88	
22002063	M2-D Pro Digital magnetical stirrer with heating stainless steel plate. Capacity 20 liters, speed: up to 1.500 RPM	88	
22002513	PT 1000 temperature probe for M2- D Pro and for M3-D	89	
22002523	Support for PT 1000 temperature probe	89	
22002533	Plastic Cover for Protection	89	
22002583	Blue carrying plate for quarter pies	89	
22002593	Red quarter pie for n. 11 tubes 4 ml, diam. 15,2 mm.	89	
22002603	Violet quarter pie for n. 4 tubes 20 ml, diam. 28 mm.	89	
22002613	Blue quarter pie for n. 4 tubes 30 ml, diam. 28 mm.	89	
22002623	Black quarter pie for n. 4 tubes 40 ml, diam. 28 mm	89	
22002633	Green quarter pie for n. 6 tubes 8 ml, diam. 17,8 mm.	89	
22002643	Gold quarter pie for n. 4 tubes 16 ml, diam. 21,6 mm.	89	
22002663	Reaction block for 100 ml round bottom flask	89	
22002673	Reaction block for 250 ml round bottom flask	89	
22002683	Reaction block for 500 ml round bottom flask	89	
22003013	M3-D Digital magnetical stirrer with heating ceramic plate, capacity 10 liters. Speed: up to 1.500 RPM	88	
22005013	AM 20-D Overhead stirrer, capacity 20 Liters, LED display. Speed adjustable from 50 to 2.200 RPM.	90	
22005043	AM 40-D Overhead stirrer, capacity 40 Liters, LCD display. Speed adjustable from 50 to 2.200 RPM.	90	
22005153	Support for Overhead stirrer AM 20-D and AM 40-D	91	
22005163	Crossed stirrer, shaft length 400 mm, stirrer diameter 50mm	91	
22005173	Straight stirrer, shaft length 400 mm, stirrer diameter 60mm	91	
22005183	Blade stirrer, shaft length 400 mm, stirrer diameter 68mm	91	
22005193	Centrifugal stirrer, shaft length 400 mm, stirrer diameter 89mm	91	
22005303	Crossed stirrer, shaft length 400 mm, stirrer diameter 50mm PTFE	91	
22005313	Straight stirrer, shaft length 400 mm, stirrer diameter 60mm PTFE	91	
22005323	Blade stirrer, shaft length 400 mm, stirrer diameter 68mm PTFE	91	
22005333	Centrifugal stirrer, shaft length 400 mm, stirrer diameter 89mm PTFE	91	
22006013	SKO-D XL Orbital shaker, capacity 7.5 Kg, plate 320X320 mm, double display for speed and timer control	92	
22006023	SKO-D-XL 3D Shaker, capacity 5 Kg, plate 320X320 mm, double display for speed and timer control	92	
22006033	SKO-D-XL LINEAR Shaker capacity 7.5 Kg, plate 320X320 mm, double display for speed and timer control	92	
22006223	Dish platform with non-slip mat.	92	
22006233	Universal support for orbital shaker with 4 roll.	92	
22006243	Support for fixing clip	92	
22006453	Fixing clip for 25 ml	92	
22006463	Fixing clip for 50 ml	92	
22006473	Fixing clip for flask 100 ml	92	
22006483	Fixing clip for flask 200/250 ml	92	
22006493	Fixing clip for flask 500 ml	92	
22006553	Bar for Universal support	92	
22008013	Mixer Vortex for tubes with "touch" and continue control speed	91	
22008103	Universal support for Argolab MIX	91	
22008113	Adapter for 6 mm tubes - 48 places	91	
22008123	Adapter for 12 mm tubes - 16 places	91	
22008133	Adapter for 16 mm tubes - 8 places	91	
22008143	Standard top cup	91	
22008153	Adapter for 10 mm tubes - 15 places	91	
22008163	Platform pad	91	

p/n	DESCRIPTION		NOTE
22010013	HB 120 C Dry bath	113	
22010103	BATHTUB + SPHERES	114	
22010113	BATHTUB	114	
22010123	54 places x 0,2 ml	114	
22010133	40 places x 0,5 ml	114	
22010143	40 places x 1,5 ml	114	
22010153	40 places x 2,0 ml	114	
22010163	18 places x 0,2 / 0,5 / 1,5 / 2 [ml]	114	
22010173	28 places x 5/15 ml	114	
22010183	45 places x 5 ml	114	
22010193	8 places x 50 ml	114	
22010203	Microplates	114	
22010213	ALUMINUM SPHERES - 1 Kg	114	
27000113	BL 3001, digital balance, max. capacity 3000 g, resolution 0,1 g, counting samples function, various units measure	71	
27000123	BL 6001, digital balance, max. capacity 6000 g, resolution 0,1 g, counting samples function, various units measure	71	
27000133	BL 30K1, digital balance, max. capacity 30 kg, resolution 0,1 g, counting samples function, various units measure.	72	
27000293	BL 6001 BASIC, digital balance, max. capacity 6000 g, resolution 0,1 g, counting samples function	71	
27000303	BL 2002 BASIC, digital balance, max. capacity 2000 g, resolution 0,01 g, counting samples function	71	
27000313	BL 2002, digital balance, max. capacity 2000 g, resolution 0,01 g, counting samples function, various units measure	70	
27000323	BL 602, digital balance, max. capacity 600 g, resolution 0,01 g, counting samples function, various units measure	69	
27000513	BL 303, digital balance, max. capacity 300 g, resolution 0,001 g, counting samples function, various units measure	69	
27000803	Dust soft Cover for XS Balances	74	
27000813	Class M1 Weight of 100 g for XS Balances	74	
27000823	Class M1 Weight of 1000 g for XS Balances	74	
27000863	Printer RS 232 for XS Balances	74	
27000883	Set of 50 sample plates	73	
27000903	Certificate DKD/Accredia Traceability for XS Balances	74	
27001003	BW 3000 WATERPROOF, digital balance double display, max. capacity 3000 g, resolution 1 g	73	
27001203	BL 30K, digital balance, max. capacity 30 kg, resolution 1 g, counting samples function, various units measure.	72	
27001213	BL 100K, digital balance with removable display, max. capacity 100 kg, resolution 10 g, counting samples function	72	
27001303	BM 113, digital MOISTURE balance, max. capacity 110 g, resolution 0,001 g, halogen lamp 400 W, 15 drying programs.	72	
27005993	BL 224 BASIC, digital balance, max. capacity 220 g, resolution 0,1 mg, external calibration, counting samples function	69	
27006003	BL 224, digital balance, max. capacity 220 g, resolution 0,1 mg, internal calibration, counting samples function	68	
27006013	BL 224 TOUCH, digital balance touch screen display, max. capacity 220 g, resolution 0,1 mg, internal calibration	68	
32105102	ORP electrode for pH 7 and pH 70, cable lenght 5 mt BNC plug	10	
32105223	pH GEL electrode plastic body for pH 7 and pH 70, cable lenght 1 mt BNC	10	
32105302	ORP electrode for pH 7 and pH 70, cable lenght 1 mt BNC plug	10	
32200103	pH electrode mod. 201 T DHS with temp. 1 mt BNC cable	39	
32200113	pH electrode mod. 2 PORE T DHS, Cable fix / BNC, with temperature sensor NTC 30	39	
32200123	pH electrode mod. Standard T BNC DHS with temp. 1 mt BNC cable	39	
32200133	pH digital electrode mod. FLOW TEMP DHS, S7 cable fix/BNC	39	
32200143	pH digital electrode mod. 2 PORE F DHS, Cable fix / BNC, with temperature sensor	39	
32200153	pH electrode mod. 201 T DHS temperature sensor in-build, cable lenght 3 mt BNC/Cinch plug	35	
32200203	pH electrode mod. GEL, S7 head, for general application	41	
32200213	pH electrode mod. MICRO, S7 head, Electrolyte KCl 3M, for small volume s	42	
32200223	XS Polymer S7 pH electrode	41	
32200233	ORP electrode mod. STANDARD ORP, range mV \pm 2000 mV, temp. -10...+100 °C, S7 head, Platinum ring for ORP/Redox	46	

p/n	DESCRIPTION		NOTE
32200243	pH electrode mod. FOOD SLIM, S7 head	43	
32200253	pH electrode mod. MICRO P, S7 head, Electrolyte Glycerine KCl 3M	42	
32200263	pH electrode mod. STANDARD BNC, Cable fix / BNC, for general application	40	
32200273	pH electrode mod. STANDARD DIN, Cable fix / DIN, for general application	40	
32200283	pH electrode mod. 2 PORE SLIM, S7 head	43	
32200293	pH electrode mod. 2 PORE F, S7 head	44	
32200303	pH electrode mod. 2 PORE K complete, S7 head, with knife	44	
32200313	pH electrode mod. 2 PORE STEEL T, Cable fix / BNC, with temperature sensor NTC 30	44	
32200323	pH electrode mod. 2 PORE T, Cable fix / BNC, with temperature sensor NTC 30 KΩ plug	43	
32200333	pH electrode mod. 2 PORE, range pH 0...14, temp.0...+60 °C, S7 head	43	
32200343	pH electrode mod. 2 PORE K without knife, range pH 0...14, temp. 0...+60 °C, S7 head, without knife	44	
32200353	Blade for 2 PORE K	44	
32200363	XS Standard pH electrode	40	
32200373	pH electrode mod. FLOW, range pH 0...14, temp. -10...+80 °C, S7 head, for viscous sample and low ion media	41	
32200383	pH electrode mod. SEMI MICRO, range pH 0...14, temp. -10...+100 °C, S7 head, for test tube measurements	42	
32200393	pH electrode mod. FOOD, range pH 0...14, temp.-10...+100 °C, S7 head, Glycerine KCl electrolyte	43	
32200403	pH electrode mod. ZAVATRODE, S7 head, for cheese measurements	43	
32200413	pH electrode mod. FLAT, S7 head, for surface measurements e. g. paper	42	
32200423	pH electrode mod. STANDARD HA, S7 head, for Minimal alkali error	40	
32200433	pH electrode mod. STANDARD HF, S7 head, for sample with HF (0,01M/200 mg/l)	40	
32200443	pH electrode mod. POLYMER TIP, S7 head, 2 Diaphragm open pore	41	
32200453	pH electrode mod. MICRO SPECIAL, S7 head, for measure in NMR tube	42	
32200463	pH electrode mod. STANDARD T DIN, Cable fix / DIN, with temperature sensor	40	
32200473	pH electrode mod. STANDARD T-BNC, Cable fix / BNC, with temperature sensor	40	
32200483	ORP electrode mod. STANDARD Ag, S7 head, Silver tip	46	
32200493	pH electrode mod. POLYMER PLAST , S7 head	45	
32200503	pH electrode mod. POLYMER PLAST BNC, Cable fix / BNC	45	
32200513	pH electrode mod. POLYMER PLAST DIN, Cable fix / DIN	45	
32200523	STANDARD KF, S7 head, double platinum pin for KF and SO ₂ titrations	46	
32200543	FLOW AG Collar diaphragm, S7 head with silver tip for argentometric applications	46	
32200643	pH electrode mod. 2 PORE STEEL T DIN , Cable fix / DIN, with temp. sensor NTC 30	44	
32200663	ORP electrode mod. Plast ORP, S7 head, Platinum pin for ORP/Redox	46	
32200673	ORP electrode mod. Plast ORP BNC Cable fix / BNC, Platinum pin for ORP/Redox	46	
32200703	pH electrode mod. 2 PORE F Temp BNC, Cable fix / BNC, with temp. sensor NTC 30	44	
32200713	pH electrode mod. 2 PORE F Temp DIN, Cable fix / DIN, with temperature sensor PT 1000	44	
32200723	pH electrode mod. FLOW Temp BNC ,Cable fix / BNC, with temperature sensor	41	
32200733	pH electrode mod. FLOW Temp DIN , Cable fix / DIN, with temperature sensor	41	
32208003	3M KCl XS Sensor Electrolyte solution, package 55ml	45	
32208013	3M KCl XS Sensor Electrolyte solution, package 500ml	45	
32208023	GLYCERIN-KCl XS Sensor Electrolyte solution, package 55 ml	45	
32208033	KN ₀₃ 1M Electrolyte solution for XS Sensor STANDARD Ag, package 55 ml	45	
32208043	XS Sensor STORAGE Solution, package 55 ml	45	
32208053	XS Sensor STORAGE Solution, package 500 ml	45	
32208063	PROTEIN CLEANING Solution (pepsin) for XS Sensor, package 55 ml	45	
32208073	DIAPHRAGM CLEANING solution (thiourea) for XS Sensor, package 55 ml	45	
32208083	REGENERATION Solution for XS Sensor pH electrode, package 55 ml	45	
32208093	PROTEIN CLEANING Solution (pepsin) for XS Sensor, bottle 250 ml	45	

p/n	DESCRIPTION		NOTE
32208103	DIAPHRAGM CLEANING solution (thiourea) for XS Sensor, bottle 250 ml	45	
32382903	1x55 ml XS buffer solution pH 10,01 ± 0,02 / 25°C colourless, without certificate	51	
32383123	1x55 ml XS buffer solution pH 4,01 ± 0,02 / 25°C red color, without certificate	51	
32383133	1x55 ml XS buffer solution pH 7,00 ± 0,02 / 25°C green color, without certificate	51	
32383143	1x55 ml XS buffer solution pH 9,00 ± 0,02 / 25°C blue color, without certificate	51	
32383163	1x55 ml XS buffer solution ORP-Redox mV465 ± 10mV /25°C yellow/brown color, without certificate	51	
32383153	Standard Redox 475mV 1 x 55 ml	51	
32383163	Standard Redox 465mV 1 x 55 ml	51	
33412913	S7 Head - ONLY S7 head for 5mm cable	48	
33412923	BNC - Only BNC plug for 5mm cable	48	
33550533	Coaxial cable with antistatic sheat for electrodes, diameter 5mm Price at meter	48	
33550563	Cable assembled with S7 head - BNC CONNECTOR - Lenght 5m	48	
33550663	Cable assembled with S7 head - OPEN WIRES - Lenght 5m	48	
33550673	Cable assembled with S7 head - BNC CONNECTOR - Lenght 1m	48	
33550733	Cable assembled with S7 head - OPEN WIRES - Lenght 3m	48	
33550743	Cable assembled with S7 head - BNC CONNECTOR - Lenght 3m	48	
33550753	Cable assembled with S7 head - BNC CONNECTOR - Lenght 10m	48	
33550803	Cable assembled with S7 head - OPEN WIRES - Lenght 10m	48	
33550903	DIN - Only DIN plug for 5mm cable	48	
33551733	S7 / BNC cable lenght 1mt for pH electrode	48	
33551743	1 m cable S7 / DIN	48	
40000022	R-5S+ centrifuge	84	
40000272	Fixed angle rotor R-83A, 12 x 15 ml, supplied with metal buckets and tubes. SPARE PART only for R-5S+	84	
40003402	T 15F Falcon tube 15ml	80	
40003412	T 15G Glass tube 15ml	80	
40003422	T 15P Plastic tube 15ml	80	
40003432	T 50F Falcon tube 50ml	80	
40003442	T 50G Glass tube 50ml	80	
40003452	T 50P Plastic tube 50ml	80	
40003462	T 100G Glass tube 100ml	80	
40003472	T 100P Plastic tube 100 ml	80	
40003492	T 175 Plastic flat bottom bottle 175 ml	80	
40005012	MULTISPIN 12, Mini Microcentrifuge	85	
40100302	NEYA 8 Ventilated centrifuge BASIC, 4x175 ml, 6000rpm	77	
40100312	NEYA 10 Ventilated centrifuge PROFESSIONAL, 4x175 ml, 6000rpm, 10 Programs	78	
40100322	NEYA 16 Ventilated centrifuge HIGH SPEED, 4x175 ml, 16000rpm, 10 Programs	79	
40100332	NEYA 10R Refrigerated centrifuge PROFESSIONAL, 4x175 ml, 6000rpm, 10 Programs	78	
40100342	NEYA 16R Refrigerated centrifuge HIGH SPEED, 4x175 ml, 16000rpm, 10 Programs	79	
40100502	Swing out rotor KIT SB 4-175, composed by S.O. rotor S 4-175, 4 buckets B 175 (175ml) and 4 Biosafe lids L 175	80	
40100522	Swing out rotor S 6-96 MP for MICROPLATE, supplied complete of 2 plates, max. 6x96 wells	81	
40100602	Insert I 12-2 (12 microtubes 1,5-2ml) for buckets B 175. Set of 4 pcs.	80	
40100612	Insert I 7-5/7 (7 collection tubes 5-7ml) for buckets B 175. Set of 4 pcs.	80	
40100622	Insert I 7-10 (7 collection tubes 10ml) for buckets B 175. Set of 4 pcs.	80	
40100632	Insert I 4-15F (4 Falcon/conical tubes 15ml) for buckets B 175. Set of 4 pcs.	80	
40100642	Insert I 4-15R (4 round bottom tubes 15 ml) for buckets B 175. Set of 4 pcs.	80	
40100662	Insert I 1-50R (1 round bottom tube 50 ml) for buckets B 175. Set of 4 pcs.	80	
40100672	Insert I 1-100 (1 round bottom tube 100 ml) for buckets B 175. Set of 4 pcs.	80	

p/n	DESCRIPTION		NOTE
40100682	Insert I 1-50SF (1 Falcon/conical self standing tube 50ml) for buckets B 175. Set of 4 pcs.	80	
40100802	Fixed angle rotor A 32-15 for 32 tubes 15ml	82	
40100812	Fixed angle rotor A 8-50 for 8 tubes 50ml	82	
40100822	Fixed angle rotor A 6-100 for 6 tubes 100ml	82	
40100832	Fixed angle rotor A 12-5 for 12 tubes 5ml Eppendorf, supplied with Biosafe lid ONLY for NEYA 16-16R	83	
40100842	Fixed angle rotor A 24-2 for 24 microtubes 1,5-2ml Eppendorf, supplied with Biosafe lid ONLY for NEYA 16-16R	83	
40100852	Fixed angle rotor A 36-05 for 36 microtubes da 0,5 Eppendorf, supplied with Biosafe lid ONLY for NEYA 16-16R	83	
40100862	Fixed angle rotor A 6-50 HIGH SPEED 6 tubes 50ml, supplied with Biosafe lid ONLY for NEYA 16-16R	83	
40100872	Fixed angle rotor PCR 4-8 for 4 strips of 8 PCR , supplied with Biosafe lid ONLY for NEYA 16-16R	83	
40101002	B 15F metal buckets complete of Falcon tube 15 ml. Only for F.A. rotor A 32-15	82	
40101012	B 15G metal buckets complete of Glass tube 15 ml. Only for F.A. rotor A 32-15	82	
40101022	B 15P metal buckets complete of Plastic tube 15 ml. Only for F.A. rotor A 32-15	82	
40101032	B 50XF metal buckets complete of Falcon tube 50 ml. Only for F.A. rotor A 8-50 and A 6-50	82	
40101042	B 50XG metal buckets complete of Glass tube 50 ml. Only for F.A. rotor A 8-50 and A 6-50	82	
40101052	B 50XP metal buckets complete of Plastic tube 50 ml. Only for F.A. rotor A 8-50 and A 6-50	82	
40101092	B 100G metal buckets complete of Glass tube 100 ml. Only for F.A. rotor A 6-100	82	
40101102	B 100P metal buckets complete of Plastic tube 100 ml. Only for F.A. rotor A 6-100	82	
40101262	RE 2-05 reductor for microtube from 2ml to 0,5ml. Set of 24 pcs.	83	
40101272	RE 2-02 reductor for microtube from 2ml to 0,2ml. Set of 24 pcs.	83	
40101282	RE 05-02 reductor for microtube from 0,5ml to 0,2ml. Set of 36 pcs.	83	
40101292	RE 15-5/7 reductor for tube from 15ml to 5/7ml (13x75mm and 13x100mm). Metal bucket included	83	
40101322	RE 50-15 F reductor from 50ml to 15ml Falcon/conical tube. Metal bucket included	83	
40101332	RE 50-15 R reductor from 50ml to 15ml round bottom tube. Metal bucket included	83	
40101342	RE 50-10 reductor from 50ml to 10ml collection tube. Metal bucket included	83	
40101352	RE 100-50F reductor from 100ml to 50ml Falcon/conical tube. Metal bucket included	83	
40101362	RE 100-50R reductor from 100ml to 50ml round bottom tube. Metal bucket included	83	
40101372	RE 100-15F reductor from 100ml to 15ml Falcon/conical tube. Metal bucket included	83	
40101382	RE 100-15R reductor from 100ml to 15ml round bottom tube. Metal bucket included	83	
40101502	Swing out rotor S 4-175. ONLY ROTOR	81	
40101512	Bucket B 175 (175 ml) for rotor S 4-175. One piece.	80	
40101522	Biosafe lid L 175. One piece	80	
40101532	B 2-50F carrier for 2 Falcon/conical tubes 50 ml. For rotor S 4-175 (min. 4 pieces). One piece	81	
40101542	B 7-15F carrier for 7 Falcon/conical tubes 15 ml. For rotor S 4-175 (min. 4 pieces). One piece	81	
40101552	B 12-10 carrier for 12 collection tubes 10 ml . For rotor S 4-175 (min. 4 pieces). One piece	81	
40101562	B 14-5/7 carrier for 14 collection tubes 5/7ml . For rotor S 4-175 (min. 4 pieces). One piece	81	
40101572	B 16-5/7 carrier for 16 collection tubes 5/7ml . For rotor S 4-175 (min. 4 pieces). One piece	81	
40101582	B 2-50R carrier for 2 round bottom tubes 50 ml. For rotor S 4-175 (min. 4 pieces). One piece	81	
40101592	B 7-15R carrier for 7 round bottom tubes 15 ml. For rotor S 4-175 (min. 4 pieces). One piece	81	
41100002	TCN 50 PLUS - natural convection oven	100	
41100012	TCN 115 PLUS - natural convection oven	100	
41100022	TCN 200 PLUS - natural convection oven	100	
41100062	TCN 30 PLUS - natural convection oven	100	
41100102	Steel wire shelf for TCN 50 / TCF 50	101	
41100112	Steel wire shelf for ICF 120	107	
41100122	Steel wire shelf for ICF 200	107	
41100132	Steel wire shelf for ICF 400	107	
41100142	Steel wire shelf for TCN 30	101	

p/n	DESCRIPTION		NOTE
41100152	Steel holed platform applicable to wire shelf for TCN 50 / TCF 50	101	
41100162	Steel holed platform applicable to wire shelf for ICF 120	107	
41100172	Steel holed platform applicable to wire shelf for ICF 200	107	
41100182	Steel holed platform applicable to wire shelf for ICF 400	107	
41100192	Steel holed platform applicable to wire shelf for TCN 30	101	
41100202	TCF 50 PLUS - forced air oven with 7 programs x 10 steps, +10°C RT...300°C, 50 Lt volume, digital controller.	102	
41100212	TCF 120 PLUS - forced air oven with 7 programs x 10 steps, +10°C RT...300°C, 120 Lt volume, digital controller	102	
41100222	TCF 200 PLUS - forced air oven with 7 programs x 10 steps, +10°C RT...300°C, 200 Lt volume, digital controller	102	
41100232	TCF 400 PLUS - forced air oven with 7 programs x 10 steps, +10°C RT...300°C, 400 Lt volume, double door opening	102	
41100502	TCN 50 SUPER touch screen colour display. 8 programs of 8 steps each one. Unlimited data memory with USB port	100	
41100512	TCN 115 SUPER touch screen colour display. 8 programs of 8 steps each one. Unlimited data memory with USB port	100	
41100522	TCN 200 SUPER touch screen colour display. 8 programs of 8 steps each one. Unlimited data memory with USB port	100	
41100602	TCF 50 SUPER touch screen colour display. 8 programs of 8 steps each one. Unlimited data memory with USB port	102	
41100612	TCF 120 SUPER touch screen colour display. 8 programs of 8 steps each one. Unlimited data memory with USB port	102	
41100622	TCF 200 SUPER touch screen colour display. 8 programs of 8 steps each one. Unlimited data memory with USB port	102	
41100632	TCF 400 SUPER touch screen colour display. 8 programs of 8 steps each one. Unlimited data memory with USB port	102	
41100802	ICF 55 PLUS - forced air incubator with 7 programs x 10 steps, +5°C RT...70°C	106	
41100812	ICF 120 PLUS - forced air incubator with 7 programs x 10 steps, +5°C RT...70°C	106	
41100822	ICF 200 PLUS - forced air incubator with 7 programs x 10 steps, +5°C RT...70°C,	106	
41100832	ICF 400 PLUS - forced air incubator with 7 programs x 10 steps, +5°C RT...70°C	106	
41100902	ICF 55 SUPER touch screen colour display. 8 programs of 8 steps each one. Unlimited data memory with USB port	106	
41100912	ICF 120 SUPER touch screen colour display. 8 programs of 8 steps each one. Unlimited data memory with USB port	106	
41100922	ICF 200 SUPER touch screen colour display. 8 programs of 8 steps each one. Unlimited data memory with USB port	106	
41100932	ICF 400 SUPER touch screen colour display. 8 programs of 8 steps each one. Unlimited data memory with USB port	106	
41101002	ICN 16 PLUS - natural convection incubator with 7 programs x 10 steps, +5°C RT...70°C, 16 Lt volume, digital controller	104	
41101012	ICN 35 PLUS - natural convection incubator with 7 programs x 10 steps, +5°C RT...70°C, 35 Lt volume, digital controller	104	
41101022	ICN 55 PLUS - natural convection incubator with 7 programs x 10 steps, +5°C RT...70°C, 55 Lt volume, digital controller	104	
41101032	ICN 120 PLUS - natural convection incubator with 7 programs x 10 steps, +5°C RT...70°C, 120 Lt volume	104	
41101042	ICN 200 PLUS - natural convection incubator with 7 programs x 10 steps, +5°C RT...70°C, 200 Lt volume	104	
41101112	Steel wire shelf for ICN 16	105	
41101122	Steel wire shelf for ICN 35	105	
41101132	Steel wire shelf for ICN 55	105	
41101142	Steel wire shelf for ICN 120	105	
41101152	Steel wire shelf for ICN 200	105	
41101172	Wheels for ICN 200, TCN 200, TCF 200, TCF 400 - Set of 4 pcs.	105	
41101302	ICN 16 SUPER touch screen colour display. 8 programs of 8 steps each one. Unlimited data memory with USB port	104	
41101312	ICN 35 SUPER touch screen colour display. 8 programs of 8 steps each one. Unlimited data memory with USB port	104	
41101322	ICN 55 SUPER touch screen colour display. 8 programs of 8 steps each one. Unlimited data memory with USB port	104	
41101332	ICN 120 SUPER touch screen colour display. 8 programs of 8 steps each one. Unlimited data memory with USB port	104	
41101342	ICN 200 SUPER touch screen colour display. 8 programs of 8 steps each one. Unlimited data memory with USB port	104	
41101412	CH 150 air forced cooled and climatic chamber, 150 Lt vol.	109	
41101422	CH 250 air forced cooled and climatic chamber, 250 Lt vol.	109	
41101462	Steel wire shelf for climatic chamber CH 150	109	
41101472	Steel wire shelf for climatic chamber CH 250	109	
41101512	IC 150-R PLUS air forced cooled incubator, with 7 programs x 10 steps 0 °C...60 °C, 150 Lt volume, digital controller	108	
41101562	Steel wire shelf for cooling Incubator IC 150-R	108	
41101592	WB 5 waterbath, +5 °C RT...100°C, 5 Lt volume, digital controller, safety class 2.0, closing lid	111	

p/n	DESCRIPTION		NOTE
41101602	WB 12 waterbath, +5 °C RT...100°C, 12 Lt volume, digital controller, safety class 2.0, closing lid	111	
41101612	WB 22 Pump waterbath with recirculation pump, +5 °C RT...85°C, 22 Lt volume, digital controller, safety class 2.0	111	
41101622	WB 40 Pump waterbath with recirculation pump, +5 °C RT...85°C, 40 Lt volume, digital controller, safety class 2.0	111	
41101712	WB 22 waterbath, +5 °C RT...100°C, 22 Lt volume, digital controller, safety class 2.0, closing lid	111	
41101732	SB 35 waterbath with mechanical shaking electronic speed control(Dubnoff), +5 °C RT...85°C, 35 Lt volume	112	
41101802	Rack 1 for tubes Ø13mm / 20 positions	111	
41101812	Rack 2 for tubes Ø18mm / 20 positions	111	
41101822	Rack 3 for tubes Ø31mm / 5 positions	111	
41101842	Rack 4 for tubes Ø56mm / 8 positions (biberon)	111	
41101852	Rack 5 for blood bags / 5 positions	111	
41101872	Side Handle	111	
41102012	SKI-4 air forced shaking incubator, +5 °C RT...60 °C, 7 flasks of 500 ml / 4 flasks of 1000 ml capacity, digital controller	94	
41102022	SKI-8 air forced shaking incubator	95	
41102032	SKI-8 R air forced shaking cooling incubator	95	
41102042	Platform 4 bars	95	
41102052	Platform dish with non-slip bar	95	
41102072	Universal platform with nr. 4 adjustable bars for SKI 8 R	95	
41102082	Support with anti-slip film (fixing bands included) for SKI 8 R	95	
41102112	Holed platform for flask clips	95	
41102122	Perforated support for fixing clips for SKI 8 R	95	
41102132	Fixing clip for flask volume 100 ml for SKI 4	95	
41102142	Fixing clip for flask volume 200/250 ml for SKI 4	95	
41102152	Fixing clip for flask volume 500 ml for SKI 4	95	
41102162	Fixing clip for flask volume 1000 ml for SKI 4	95	
41102172	Fixing clip for flask volume 2000 ml for SKI 4	95	
41102202	CB 5-10 Refrigerated/Heating Circulating bath (working range -10÷100 °C) supplied as standard with PT100 probe	110	
41102212	CB 5-20 Refrigerated/Heating Circulating bath (working range -20÷100 °C) supplied as standard with PT100 probe	110	
41102222	CB 5-30 Refrigerated/Heating Circulating bath (working range -30÷100 °C) supplied as standard with PT100 probe	110	
41102302	Set of 2 tubes of 2 meters with insulating material (working range -40 ÷ +60 °C), complete with metal clamps	110	
41102312	Set of four swivelling wheels, two of which brakeble	110	
41102322	Premixed thermal fluid ready to use, working range -30 ÷ + 80 °C. Tank box 5 litres with plastic tap	110	
41110142	Hole 50 mm complete of closing caps for incubators ICF	107	
41110152	Hole 25 mm complete of closing caps for incubators ICF	107	
41119002	IQ-00 paper manual for all oven and incubators	107	
41300203	SS-200 sieve adjustable holder for 5pcs sieve 80mm H or 6 pcs sieve 60mm H ONLY FOR MODEL AU-450	116	
41300253	Concentrate Universal Cleaner 30 ml	116	
41300263	Concentrate Universal Cleaner 500 ml	116	
41300303	CE-5700A Digital ultrasonic cleaner, max capacity 0,75 L, NO heating, timer 90/180/280/380/480 sec.	115	
41300323	DU-06 Digital ultrasonic cleaner, max capacity 0,6 L, NO heating, timer 180/360 sec.	115	
41300333	DU-32 S Digital ultrasonic cleaner, max capacity 3,2 L, Temperature range to 80°C, Timer 1-99min	115	
41300343	DU-45 S Digital ultrasonic cleaner, max capacity 4,5 L, Temperature range to 80°C, Timer 1-99min	115	
41300353	DU-65 S Digital ultrasonic cleaner, max capacity 6,5 L, Temperature range to 80°C, Timer 1-99min	115	
41300363	DU-100 S Digital ultrasonic cleaner, max capacity 10 L, Temperature range to 80°C, Timer 1-99min	115	
41300373	DU-220 S Digital ultrasonic cleaner, max capacity 22 L, Temperature range to 80°C, Timer 1-99min	115	
41300383	DU-450 S Digital ultrasonic cleaner, max capacity 45 L, Temperature range to 80°C, Timer 1-99min	115	
41300403	AU-32 Analogic ultrasonic cleaner, max capacity 3,2 L, Temperature range to 80°C, Timer 1-50 min.	116	
41300413	AU-65 Analogic ultrasonic cleaner, max capacity 6,5 L, Temperature range to 80°C, Timer 1-50 min.	116	

p/n	DESCRIPTION		NOTE
41300423	AU-450 Analogic ultrasonic cleaner, max capacity 45 L, Temperature range to 80°C, Timer 1-50 min.	116	
41300433	AU-220 Analogic ultrasonic cleaner, max capacity 22 L, Tank size 500x300x150 (H) mm. Temperature range to 80°C	116	
41300513	Becker support 2 hole - for DU-45	116	
41300523	Becker support 2 hole - for DU-65 - AU-65 - AU-220	116	
41300533	Becker support 4 hole - for DU-100 and AU-220	116	
41400103	Ozone Generator OZ-10 with timer (10gr/h)	96	
41400203	Ozone Generator OZ-30 with timer (30gr/h)	96	
41500012	FR 110 refrigerator	118	
41500022	FR 110 G refrigerator	118	
41500032	FR 260 refrigerator	118	
41500042	FR 260 G refrigerator	118	
41500212	FZ 110 freezer	119	
41500232	FZ 260 freezer	119	
41500702	Standard shelf	119	
41500712	Bottom shelf compatible with all models	119	
43000003	Replaced Cover with LED	142	
43000013	101, for sugar 0-32% Brix- Standard cover (NO LED)	142	
43000023	102, for sugar 28-62% Brix - Standard cover (NO LED)	142	
43000033	103, for sugar 0-80% Brix-Standard cover (NO LED)	142	
43000043	104, for Honey, 58-92% Sugar- 12-27% Water- 38-43°Beaumè- Standard cover (NO LED)	142	
43000053	105, Urine, 0-12g/dl Sierum, 1,000-1,050 sg Urine, 1,3330-1,3600 nD Refractive Index - Standard cover (NO LED)	142	
43000063	106, for Salinity 0-28% NaCl - Standard cover (NO LED)	142	
43000103	101 ATC (Automatic Temperature compensation), for sugar 0-32% Brix-Standard cover (NO LED)	142	
43000113	106 ATC, for Salinity 0-100‰ NaCl (Sea water) - Standard cover (NO LED)	142	
43000123	107 ATC, for Wine 0-32% Brix, 0-28 KM/W Babo - Standard cover (NO LED)	142	
43000133	110 ABBE, 1,3000/1,7000 nD - 0,0/95,0 %Brix included digital thermometer	142	
43000153	Replaced digital thermometer for 110 Abbe	142	
43000163	Replaced Standard cover (NO LED)	142	
43000173	414 ATC, for Antifreeze and Battery -50°C-0°C EG Ethilen Glicol, -50°C-0°C PG Propilen Glicol, -40°C-0°C CW	142	
43000193	UREA Refractometer 0-40%	142	
43000203	101 ATC LED (Automatic Temperature compensation), for sugar 0-32% Brix- Cover with LED	142	
43000223	103 LED, for sugar 0-80% Brix-Cover with LED	142	
43000233	107 ATC LED, for Wine 0-32% Brix, 0-28 KM/W Babo - Cover with LED	142	
44000053	DBR SAL Multiscale digital, 0,0-28,0 % Salinity - Temperature 0,0-70,0°C	140	
44000063	DBR 95 Multiscale digital, 0,0-95,0 % Brix, 1,3333-1,5318 nD, 0,0-40,0°C	140	
44000073	DBR 55, Multiscale digital, 0,0-55,0 % Brix, 1,3333-1,4098 nD, 0,0-40,0°C	140	
44000083	DBR Coffee Multiscale digital, 0,0-26,0 % Brix, TDS 0,00-23%, 0,0-70,0°C	141	
44000093	DBR Wine Multiscale digital, 0,0-55,0 % Brix	141	
50000112	Electrode holder with flexible arm mod. 3900	11	
50000132	Magnetical stirrer ST 10 with rechargeable battery	11	
50001052	Power supply for 50 and 60 series	11	
50001132	Integrated magnetical stirrer for 8 serie	5	
50101192	pH 8 PRO BASIC with pH electrode XS STANDARD T BNC DHS. Cable S7/BNC, temperature probe NT55	5	
50101202	pH 8 PRO BASIC with pH electrode XS POLYMER. Cable S7/BNC, temperature probe NT55	5	
50101212	pH 8 PRO BASIC without pH electrode. Cable S7/BNC, temperature probe NT55	5	
50101232	pH 8 PRO STIRRER with pH electrode XS POLYMER. Cable S7/BNC, temperature probe NT55	5	
50101242	pH 8 PRO STIRRER without pH electrode. Cable S7/BNC, temperature probe NT55	5	

p/n	DESCRIPTION		NOTE
50101252	pH 8 PRO STIRRER with pH electrode XS STANDARD T BNC DHS. Cable S7/BNC, temperature probe NT55	5	
50101392	pH 80 PRO STIRRER with pH electrode XS STANDARD T BNC DHS, cable S7/BNC, temperature probe NT55	4	
50101402	pH 80 PRO STIRRER with pH electrode XS STANDARD, temperature probe NT55, S7/BNC 1 m cable	4	
50101412	pH 80 PRO STIRRER without pH electrode. Cable S7/BNC, temperature probe NT55	4	
50101422	pH 80 PRO BASIC with pH electrode XS STANDARD, temperature probe NT55, S7/BNC 1 m cable	4	
50101432	pH 80 PRO BASIC without pH electrode. Cable S7/BNC, temperature probe NT55	4	
50101442	pH 80 PRO BASIC with pH electrode XS STANDARD T BNC DHS, cable S7/BNC, temperature probe NT55	4	
50001462	External Keyboard only for 80 serie	4	
50001472	IQ-OQ paper manual	4	
50001502	External printer for pH60-COND60-PC60 and 8-80 series - Normal Paper	6	
50001512	Power supply 12V/220 Vac for 8 and 80 series	5	
50002002	pH electrode mod. 201 T with temp. 1 mt BNC cable	10	
50002012	NT 55 Temperature probe with 1mt cable and Cinch plug	11	
50002022	pH electrode mod. 201 T/5 temperature sensor inside for pH 7 and pH 70, cable lenght 5 mt BNC/Cinch plug	10	
50002052	pH electrode mod. 201T DIN, range pH 0...14, temp. 0...+60 °C, Cable fix / DIN, with temperature sensor NTC 30	45	
50002072	pH electrode mod. 201 T temperature sensor integrated, cable lenght 3 mt BNC/Cinch plug	35	
50002082	NT 55 Temperature probe with 3mt cable and Cinch plug type NTC 30K	35	
50103202	COND 8 PRO BASIC with conductivity cell 2301T. Standard solution 1413 µS and 12,88 mS, cell holder	15	
50103212	COND 8 PRO BASIC without conductivity cell. Standard solution 1413 µS and 12,88 mS, cell holder	15	
50103232	COND 8 PROSTIRRER with conductivity cell 2301T. Standard solution 1413 µS and 12,88 mS	15	
50103242	COND 8 PRO STIRRER without conductivity cell. Standard solution 1413 µS and 12,88 mS	15	
50003352	VPT 1 Cond. Cell C=1 with ATC, glass body, cable lenght 1 mt BNC/Cinch	61	
50003372	VPT 10H Cell Glass-Pt C=10+ATC range 100 to 500mS	61	
50103402	COND 80 PRO STIRRER with conductivity cell Glass-Pt VPT80/1, standard solution 1413 µS and 12,88 mS	14	
50103412	COND 80 PRO STIRRER without conductivity cell. Standard solution 1413 µS and 12,88 mS	14	
50103422	COND 80 PRO BASIC with conductivity cell Glass-Pt VPT80/1, standard solution 1413 µS and 12,88 mS	14	
50103432	COND 80 PRO BASIC without conductivity cell. Standard solution 1413 µS and 12,88 mS	14	
50004002	Conductivity cell mod. 2301T with ATC, C=1, measuring range 10uS...200mS, cable lenght 1 mt BNC/Cinch	47	
50004012	Conductivity cell mod. VPT 01 with ATC, C=0,1, measuring range 0,1uS...1mS	47	
50004022	Conductivity cell mod. 2301T/5 with ATC, C=1, measuring range 10µS...100mS, cable lenght 5 mt BNC/Cinch	20	
50004062	Conductivity cell mod. VP 1, measuring range 10 µS...10 mS, temp. 0...+80 °C, Cable fix / BNC, cell constant C= 1.	47	
50004072	Conductivity cell mod. VPT 10, measuring range 100 µS...200 mS, temp. 0...+80 °C, Cable fix / BNC	47	
50004082	Conductivity cell mod. VPT SOIL for soil conductivity measurement with ATC, C=1, measuring range 10 µS...50mS	47	
50004092	Conductivity cell C=1 with built-in temperature sensor, epoxy body, cable 3m. Working range: 10 uS...200 mS	35	
50104132	PC 8 PRO STIRRER with pH electrode XS STANDARD T BNC DHS, conductivity cell 2301T with ATC.	25	
50104142	PC 8 PRO STIRRER with pH electrode XS Polymer, conductivity cell 2301T with ATC. Cable S7/BNC	25	
50104152	PC 8 PRO STIRRER without pH electrode, with cond. cell 2301T. Cable S7/BNC, temperature probe NT55	25	
50104162	PC 8 PRO STIRRER with pH electrode XS Polymer, without cond. cell. Cable S7/BNC. Temp. probe NT55	25	
50104172	PC 8 PRO STIRRER without pH electrode and cond. cell. Cable S7/BNC, temperature probe NT55	25	
50104232	PC 80 PRO STIRRER with pH electrode XS STANDARD T BNC DHS, cable S7/BNC, temperature probe NT55	24	
50104242	PC 80 PRO STIRRER with pH electrode XS STANDARD S7, 1 mt cable S7/BNC, temperature probe NT55	24	
50104252	PC 80 PRO STIRRER without pH electrode, with cond. cell glass VPT 80/1. Cable S7/BNC, temp. probe NT55	24	
50104262	PC 80 PRO STIRRER with pH electrode XS STANDARD S7, without cond. cell. Cable 1 mt cable S7/BNC	24	
50104272	PC 80 PRO STIRRER without pH electrode and cond. cell. Cable S7/BNC, temperature probe NT55	24	
50010172	Power supply USB for 70 series	36	
50010242	Polarographic sensor OXY D07/3MT with 3 meter cable, 2 membrane and filling solution (30ml)	35	
50010252	Kit 2 membrane for sensor OXY D07/3MT	35	

p/n	DESCRIPTION		NOTE
50010262	Filling solution for electrode OXY DO7/3MT 1x 120ml	35	
50010272	Standard zero (0) Oxygen, single use. Kit of 5 bottle for DO7/3MT, LD070/2MT, LD070/10MT	35	
50010282	Plastic armature (PPE) for electrode immersion DO7/3MT (to be ordered with OXY 7)	35	
50010292	Standard zero (0) Oxygen single use 1 bottle for DO7/3MT, LD070/2MT, LD070/10MT	35	
50010342	Optical sensor LD070/2MT with 2 meter cable	34	
50010352	Optical sensor LD070/10MT with 10 meter cable	34	
50010362	Replaced membrane LDO for sensor LD070/2MT and LD070/10MT	34	
50010372	Steel armature for sensor immersion LD070/10MT	34	
50010962	Soft case with shoulder strap in eco-friendly material for portable meters Violine	36	
50010972	IP67 carrying case for REVIO instruments	36	
50011122	NT7P, Penetration measurements, mm 150x4	112	
50011142	NT7L, For measurements in liquids/air, mm 200x3	112	
50014003	pH 1 Tester ECOPACK - 0,1 pH resolution, with ATC (automatic temperature compensation), fix electrode	61	
50014013	pH 1 Tester KIT - 0,1 pH resolution, with ATC (automatic temperature compensation), fix electrode, in carton case	61	
50014053	pH 5 Tester ECOPACK - 0,01 pH resolution, with ATC (automatic temperature compensation)	62	
50014063	pH 5 Tester KIT - 0,01 pH resolution, with ATC (automatic temperature compensation)	62	
50014073	pH 5 Tester only BODY instrument - 0,01 pH resolution, with ATC (automatic temperature compensation)	62	
50014113	pH 5 FOOD Tester KIT - 0,01 pH resolution, with ATC (automatic temperature compensation)	62	
50014123	pH 5 FOOD Tester ECOPACK - 0,01 pH resolution, with ATC (automatic temperature compensation)	62	
50014143	pX 4 Tester KIT - 0,01 pH resolution, ORP (-1000 / + 1900 mV), mV for electrode quality test, ORP	64	
50014153	COND 1 Tester ECOPACK, Cond (0,01 µS...200 mS) and TDS (0,01 ppm...199,9 ppt), with ATC	61	
50014163	COND 1 Tester KIT, Cond (0,01 µS...200 mS) and TDS (0,01 ppm...199,9 ppt), with ATC	61	
50014173	pX 4 Tester ECOPACK - 0,01 pH resolution, ORP (-1000 / + 1900 mV), mV for electrode quality test, ORP	64	
50014203	COND 5 Tester ECOPACK - Cond (0,01 µS...200 mS), TDS (0,01 ppm...199,9 ppt), Salinity (0,1 mg/l...100,0 g/l), °C/°F	63	
50014213	COND 5 Tester KIT - Cond (0,01 µS...200 mS), TDS (0,01 ppm...199,9 ppt), Salinity (0,1 mg/l...100,0 g/l), °C/°F	63	
50014223	COND 5 Tester only BODY instrument - Cond (0,01 µS...200 mS), TDS (0,01 ppm...199,9 ppt)	63	
50014253	PC 5 Tester ECOPACK - 0,01 pH resolution, mV for electrode quality test, Cond (0,01 µS...200 mS), TDS	64	
50014263	PC 5 Tester KIT - 0,01 pH resolution, mV for electrode quality test, Cond (0,01 µS...200 mS), TDS	64	
50014293	PC 6 Tester KIT - 0,01 pH resolution, mV for electrode quality test, ORP (-1000 / + 1900 mV)	65	
50014313	ORP 5 Tester KIT - ORP (-1000 / + 1900 mV) with customer calibration point, °C/°F, replaceable sensor	63	
50014403	pH 5 Replacement spare pH electrode for tester pH 5	62	
50014413	COND 5 replacement spare COND sensor for COND 5	63	
50014423	SPH 5 Replacement spare pH electrode with ATC for tester pH 5 FOOD	62	
50014433	PC 5 replacement spare PC electrode for PC 5	64	
50014443	ORP 5 replacement spare ORP sensor for ORP 5	63	
50014463	pX 4 Replacement spare pH/ORP sensor for pX 4	64	
50014483	PC 6 Replacement spare pH/ORP/COND sensor for PC 6	65	
50014713	VPT SOIL-COND5 Conductivity cell for soil conductivity measurement with ATC, C=1, measuring range 10 µS...50mS	66	
50101002	pH 50 VioLab DHS complete kit included pH electrode 201T with temperature sensor inside and BNC	7	
50101012	pH 50 VioLab DHS without pH electrode. Cable S7/BNC, temperature probe NT55	7	
50101032	pH 50 VioLab DHS complete kit included pH electrode 201T DHS with temperature sensor inside and BNC	7	
50101092	pH 60 VioLab DHS complete kit included pH electrode 201T with temperature sensor inside and BNC	6	
50101102	pH 60 VioLab DHS complete kit included pH electrode 201T DHS with temperature sensor inside and BNC	6	
50101112	pH 60 VioLab DHS without pH electrode. Cable S7/BNC, temperature probe NT55	6	
50103002	COND 50 VioLab complete kit include cond. cell 2301T with ATC, cable length 1m. Cell holder	17	
50103012	COND 50 VioLab without conductivity cell. standard calibration solutions 1413 µS and 12,88 mS, cell holder	17	
50103072	COND 60 VioLab complete kit include cond. cell 2301T with ATC, cable length 1m. Cell holder	16	

p/n	DESCRIPTION		NOTE
50103082	COND 60 VioLab without conductivity Cell. standard calibration solutions 1413 µS and 12,88 Ms	16	
50103892	PC 50 VioLab DHS complete kit with pH electrode 201T DHS with temperature sensor inside, conductivity cell	27	
50103902	PC 50 VioLab DHS complete kit with pH electrode 201T with temperature sensor inside, conductivity cell	27	
50103912	PC 50 VioLab DHS without pH electrode, included S7/BNC cable, temperature probe NT 55, conductivity cell	27	
50103942	PC 60 VioLab DHS complete kit with pH electrode 201T DHS with temperature sensor inside	26	
50103952	PC 60 VioLab DHS complete kit with pH electrode 201T with temperature sensor inside, conductivity cell	26	
50103972	PC 60 VioLab DHS without pH electrode, included S7/BNC cable, temperature probe NT 55, conductivity cell	26	
50110012	pH 7 Vio DHS complete kit included pH electrode 201T plastic body with temperature sensor inside	9	
50110022	pH 7 Vio DHS kit without pH electrode with temperature probe NT 55, BNC/S7 1mt cable, colored pH buffer	9	
50110032	pH 7 Vio DHS FOOD complete kit included pH spear electrode 2 Pore T with temperature sensor inside	9	
50110062	pH 7 Vio DHS complete kit included pH GEL electrode plastic body 1 mt. cable with BNC.	9	
50110072	pH 7 Vio DHS complete kit included pH electrode 201T DHS plastic body with temperature sensor inside	9	
50110082	pH 7 Vio DHS FOOD complete kit included pH spear electrode 2 Pore T DHS with temperature sensor inside	9	
50110112	pH 70 Vio DHS complete kit included pH electrode 201T plastic body with temperature sensor inside	8	
50110122	pH 70 Vio DHS kit without pH electrode with temperature probe NT 55, BNC/S7 1mt cable, colored pH buffer	8	
50110162	pH 70 Vio DHS FOOD complete kit included pH spear electrode 2 Pore T with temperature sensor inside	8	
50110182	pH 70 Vio DHS complete kit included pH electrode 201T DHS plastic body with temperature sensor inside	8	
50110192	pH 70 Vio DHS FOOD complete kit included pH spear electrode 2 Pore T DHS with temperature sensor inside	8	
50110202	Oxy 7 Vio with polarographic sensor OXY D07/MT with 3 mt cable, 1 bottle O Oxygen standar	35	
50110212	Oxy 7 Vio ECO only meter, without probe in carton box ECOpack	35	
50110302	Oxy 70 Vio with optical Oxygen sensor LD070/2MT with 2 mt cable. 1 bottle O Oxygen standard, power supply	34	
50110312	Oxy 70 Vio with optical Oxygen sensor LD070/10MT with 10 mt cable. 1 bottle O Oxygen standard, power supply	34	
50110412	COND 7 Vio with TDS complete kit included cond. cell 2301 T with ATC, cable lenght 1mt with BNC/Cinch plug	19	
50110422	COND 7 Vio with TDS without conductivity cell, standard calibration solution, carrying case and accessories.	19	
50110512	COND 70 Vio complete kit included cond. cell 2301 T with ATC, cable lenght 1mt with BNC/Cinch plug	18	
50110522	COND 70 Vio without conductivity cell, standard calibration solution, power supply, software PC-Link	18	
50110712	PC 7 Vio DHS complete kit included pH electrode 201T plastic body with temperature sensor inside	31	
50110722	PC 7 Vio DHS without pH electrode, included conductivity cell 2301 T with ATC, cable lenght 1mt with BNC/Cinch	31	
50110752	PC 7 Vio DHS complete kit included pH electrode 201T DHS plastic body with temperature sensor inside	31	
50110812	PC 70 Vio DHS complete kit included pH electrode 201T plastic body with temperature sensor inside	30	
50110822	PC 70 Vio DHS without pH electrode, included conductivity cell 2301 T with ATC, cable lenght 1mt with BNC	30	
50110872	PC 70 Vio DHS complete kit included pH electrode 201T DHS plastic body with temperature sensor inside a	30	
50110912	REVIEW DHS kit portable multiparameter included with sensors pH/EC/DO	29	
50110922	REVIEW DHS kit portable multiparameter included with sensors pH/DO without EC cell	29	
50110932	REVIEW DHS kit portable multiparameter without sensors pH/EC/DO	29	
50110942	REVIEW DHS kit portable multiparameter included with sensors EC/DO, without pH electrode	29	
50110952	REVIEW DHS kit portable multiparameter with 201T DHS, EC and DO sensors	29	
50111012	XS Temp 7 Vio portable thermometer for PT 100 RTD probe.	123	
50111032	XS Temp 7 Vio K/T portable thermometer for thermocouple T and K probe.	123	
50111052	XS Temp 7 Vio NTC portable thermometer for NTC probe.	124	
50111062	XS Temp 7 Vio NTC KIT L portable thermometer for NTC probe.	124	
50111082	XS Temp 70 Vio Portable thermometer data logger for 2 PT 100 RTD probes.	123	
50111092	XS Temp 7 Vio NTC KIT P portable thermometer for NTC probe.	124	
50111212	XS Temp 74 Vio	122	
50111252	XS Temp 74 Vio kit	122	
51000212	PT56C, For contact measurements, mm 200x5	126	
51000222	PT56P, Penetration measurements, mm150x4	126	

p/n	DESCRIPTION		NOTE
51000232	PT56A, For measurement in air, mm200x4	126	
51000242	PT56L 1/5 DIN, For measurements in liquids, mm 200x3	126	
51000252	PT56 TFE, Teflon cable ideal for oven and freezer, mm 100x4	126	
51000262	PT56/500, For measurements in liquids, mm 500x6	126	
51000272	PT56/1000, For measurements in liquids, mm 1000x6	126	
51000752	3K220, For measurements in liquids/air, mm 200x2	127	
51000762	3K320, mm 200x3	127	
51000772	3K350, mm 500x3	127	
51000782	3K6100, mineral oxide folding probe, mm 1000x6	127	
51000792	3K650, mineral oxide folding probe, mm 500x6	127	
51000802	3K520C, For contact measurements , mm200x5	127	
51000812	3K1200, Wire manipulable probe, mm 2000x2	127	
51000822	3K6120, mineral oxide folding probe, mm 1200x6	127	
51000832	3K415P, Penetration measurements, mm150x4	127	
51000902	3T320, For measurements in liquids/air, mm 200x3	128	
51000912	3T415, Penetration measurements, mm150x4	128	
51000922	3T520C, For contact measurements , mm200x5	128	
51000932	3T420A, For measurement in air, mm200x4	128	
51000942	3T215, Penetration measurements, mm150x2	128	
51000952	3T210, Ideal for oven and freezer, mm 100x2,5	128	
51004132	REDOX combined electrode, cable lenght 3 m.	35	
51100033	1x250 ml XS buffer solution pH 4,01 ± 0,01 / 25°C red color with N.I.S.T certificate	56	
51100043	1x250 ml XS buffer solution pH 7,00 ± 0,01 / 25°C green color with N.I.S.T certificate	56	
51100053	1x250 ml XS buffer solution pH 9,00 ± 0,02 / 25°C blue color with N.I.S.T certificate	56	
51100063	1x250 ml XS buffer solution pH 10,01 ± 0,02 / 25°C colourless with N.I.S.T. certificate	56	
51100073	1x250 ml XS buffer solution pH 9,21 ± 0,02 / 25°C blue color with N.I.S.T certificate	56	
51100133	1x500 ml XS buffer solution pH 4,01 ± 0,01 / 25°C red color with N.I.S.T certificate	56	
51100143	1x500 ml XS buffer solution pH 7,00 ± 0,01 / 25°C green color with N.I.S.T certificate	56	
51100153	1x500 ml XS buffer solution pH 9,00 ± 0,02 / 25°C blue color with N.I.S.T certificate	56	
51100163	1x500 ml XS buffer solution pH 10,01 ± 0,02 / 25°C colourless with N.I.S.T. certificate	56	
51100173	1x500 ml XS buffer solution pH 9,21 ± 0,02 / 25°C blue color with N.I.S.T certificate	56	
51100233	1x5Lt XS buffer solution pH 4,01 ± 0,01 / 25°C red color with N.I.S.T certificate	56	
51100243	1x5Lt XS buffer solution pH 7,00 ± 0,01 / 25°C green color with N.I.S.T certificate	56	
51100253	1x5Lt XS buffer solution pH 9,00 ± 0,02 / 25°C blue color with N.I.S.T certificate	56	
51100263	1x5Lt XS buffer solution pH 10,01 ± 0,02 / 25°C colourless with N.I.S.T certificate	56	
51100273	1x5Lt XS buffer solution pH 9,21 ± 0,02 / 25°C blue color with N.I.S.T certificate	56	
51100303	1x250 ml XS Redox/ORP 200 mV ± 5mV / 25°C (dark bottle)	57	
51100313	1x250 ml XS Redox/ORP 475 mV ± 5mV / 25°C	57	
51100323	1x500 ml XS Redox/ORP 475 mV ± 5mV / 25°C	57	
51100333	1x5Lt XS Redox/ORP 650 mV ± 5mV / 25°C (Politainer Cubibox)	57	
51100503	1x300 ml XS Conductivity Standard 1,3 µS/cm ± 0,1 / 25°C glass bottle with N.I.S.T certificate	57	
51100513	1x300 ml XS Conductivity Standard 5 µS/cm ± 0,1 / 25°C glass bottle with N.I.S.T certificate	57	
51100613	1x500 ml XS Conductivity Standard 84 µS/cm ± 1% / 25°C with N.I.S.T certificate	57	
51100623	1x500 ml XS Conductivity Standard 147 µS/cm ± 1% / 25°C with N.I.S.T certificate	57	
51100633	1x500 ml XS Conductivity Standard 1413 µS/cm ± 1% / 25°C with N.I.S.T certificate	57	
51100643	1x500 ml XS Conductivity Standard 12'880 µS/cm ± 1% / 25°C with N.I.S.T certificate	57	
51102013	1x20 SACHET 25ml pH 4,01 ± 0,01 / 25°C (red), with Certificate of Analysis	55	

p/n	DESCRIPTION		NOTE
51102023	1x20 SACHET 25ml pH 7,00 ± 0,01 / 25°C (green), with Certificate of Analysis	55	
51102043	1x20 SACHET 25ml pH 10,01 ± 0,02 / 25°C (yellow), with Certificate of Analysis	55	
51102053	1x20 SACHET 25ml EC 1413 µS/cm ± 1% / 25°C, with Certificate of Analysis	55	
51102063	1x20 SACHET 25ml EC 12880 µS/cm ± 1% / 25°C, with Certificate of Analysis	55	
51102083	1x20 SACHET 10ml STORAGE Solution for pH/ORP sensor	55	
51102093	1x20 SACHET 25ml Distilled Water	55	
51102203	Set CAL pH BIS 1x20 SACHET 25ml (10 x pH 4.01/7.00)	55	
51102213	Set CAL pH TRIS 1x20 SACHET 25ml (7 x pH 4.01/7.00 + 6 x pH 10.01)	55	
51102223	Set CAL COND 1x20 SACHET 25ml (10 x EC 1413/12880 µS/cm)	55	
51102233	Set CAL PC 1x20 SACHET 25ml (7 x pH 4.01/7.00 + 6 x EC 1413 µS/cm)	55	
51102243	Set REFILL pack for pH 1x20 SACHET 25ml (6 x pH 4.01/7.01/H2O + 2 x Storage 10ml)	55	
51102253	Set REFILL pack for COND 1x20 SACHET 25ml (7 x EC 1413/12880 µS/cm + 6 x H2O)	55	
51102263	Set REFILL pack for PC 1x20 SACHET 25ml (5 x pH 4.01/7.01/EC 1413 µS/cm + 3 x H2O + 2 x Storage 10ml)	55	
51300003	1x250 ml XS buffer solution pH 4,01 ± 0,01 / 25°C red color with DAKKS certificate	54	
51300013	1x250 ml XS buffer solution pH 7,00 ± 0,01 / 25°C green color with DAKKS certificate	54	
51300023	1x250 ml XS buffer solution pH 9,21 ± 0,02 / 25°C blue color with DAKKS certificate	54	
51300033	1x250 ml XS buffer solution pH 10,01 ± 0,02 / 25°C yellow with DAKKS certificate	54	
51300103	1x500 ml XS buffer solution pH 4,01 ± 0,01 / 25°C red color with DAKKS certificate	54	
51300113	1x500 ml XS buffer solution pH 7,00 ± 0,01 / 25°C green color with DAKKS certificate	54	
51300123	1x500 ml XS buffer solution pH 9,21 ± 0,02 / 25°C blue color with DAKKS certificate	54	
51300133	1x500 ml XS buffer solution pH 10,01 ± 0,02 / 25°C yellow with DAKKS certificate	54	
51300303	1x300 ml XS Conductivity Standard 1,3 µS/cm ± 0,1 / 25°C glass bottle with DFM certificate	54	
51300313	1x300 ml XS Conductivity Standard 5 µS/cm ± 0,1 / 25°C glass bottle with DFM certificate	54	
51300323	1x500 ml XS Conductivity Standard 84 µS/cm ± 1% / 25°C with DFM certificate	54	
51300333	1x500 ml XS Conductivity Standard 147 µS/cm ± 1% / 25°C with DFM certificate	54	
51300343	1x500 ml XS Conductivity Standard 1413 µS/cm ± 1% / 25°C with DFM certificate	54	
51300353	1x500 ml XS Conductivity Standard 12'880 µS/cm ± 1% / 25°C with DFM certificate	54	
60000423	1x55 ml XS buffer solution 1413 µS/cm ± 1% / 25°C colourless, without certificate	54	
60000433	1x55 ml XS buffer solution 12'880 µS/cm ± 1% / 25°C colourless, without certificate	54	
70100003	mini T Temperature datalogger	129	
70100103	mini T1 Temperature datalogger	129	
70100203	mini TH Temperature and humidity datalogger	129	
70100303	mini TB with rpobe	129	
70101003	mini 1way Single trip temperature datalogger	129	
70101013	mini 1way Single trip temperature datalogger	129	
70101043	mini 1way LCD	129	